

Malvern Hills Area of Outstanding Natural Beauty

# Guidance on the Selection and Use of Colour in Development





# Contents

## General guidance

- Introduction **3**
- How to use this guide **4**
- Principles of exterior colour design **5**
- Introduction to NCS **9**

## The colour palettes

- High Hills and Slopes and Unenclosed Commons **10**
- Principal Wooded Hills, Principal Timbered Farmlands and Wooded Hills and Farmlands **18**
- Forest Smallholdings and Dwellings (Wellington Heath village) **29**
- Settled Farmlands with Pastoral Land Use **34**
- Settled Farmlands on River Terraces and Sandstone Estatelands **39**
- Enclosed Commons **47**
- Welland **53**

## Appendices

- Appendix A: Materials **58**

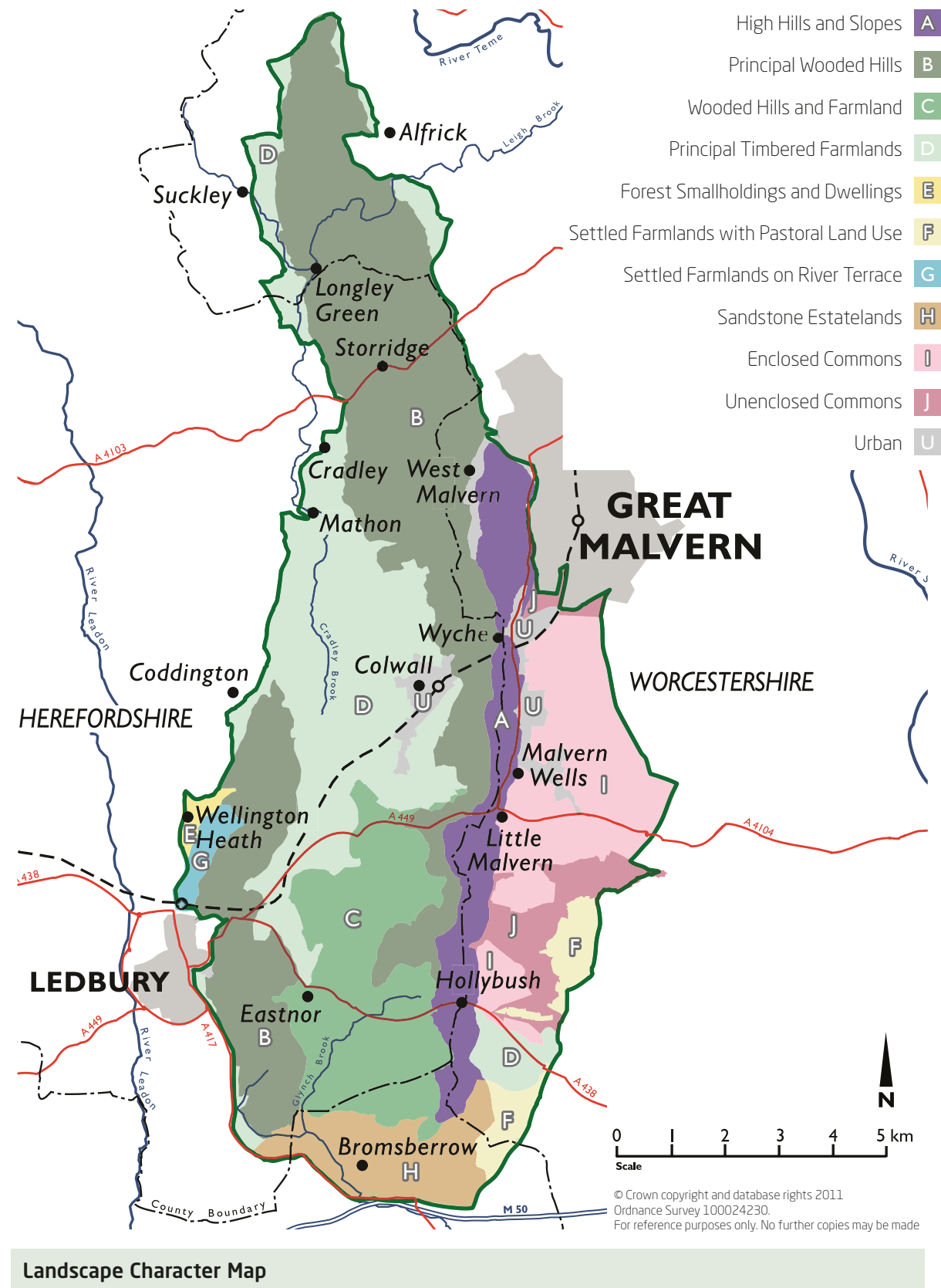

# 1 Introduction

## 1.1 Colour and the landscape

The landscape of the Malvern Hills and surrounding areas has been designated as an Area of Outstanding Natural Beauty (AONB) with the primary purpose of conserving and enhancing its natural beauty. Both natural and cultural influences have combined to produce the landscape that is so highly valued today.

Colour makes an important contribution to the special character and local distinctiveness of the area. As well as the seasonal colours of spring and autumn, the bedrock colours including granites, sandstone and limestone give rise to different soil colours and different patterns of vegetation. Management and land use also influence the colours we see, varying between improved pasture, hay meadow, woodland, traditional orchards and intensively cropped arable and horticultural land. Winter tones show the landscape at its most essential, illuminated by low winter sunlight. Local buildings comprised of brick, stone, timber, render, slate and tile etc., create another layer of colour which adds to the distinctiveness of the area.

The population of the area is growing and new development will be needed for a range of uses, not least to facilitate vital land management. It is crucial that careful consideration is given to the use of colour when selecting materials and finishes. Getting this right will help to ensure not only that new development fits with the special landscape of the AONB, but that it in turn will contribute to the local distinctiveness of the area.

## 1.2 The purpose of this document

This purpose of this document is to provide direction and guidance on the selection and use of colour associated with development within<sup>1</sup> the Malvern Hills AONB. 'Development' includes any building work, ranging from home extensions and conversions through to house building, fencing, agricultural and industrial premises, retail and office buildings. In this context, it also includes new finishes on existing structures as well as infrastructure and finishes associated with transport (e.g. roads and signage) and utilities.

This document should be read in association with the other documents published by the AONB Partnership, in particular the Guidance on Building Design which contains essential information on appropriate development within the AONB.

## 1.3 Who this document is for

This document provides guidance for everyone considering or proposing development within<sup>2</sup> the AONB, including landowners, property owners, developers, agents, advisers, architects and landscape architects. It is also targeted at those with responsibility for setting the framework for development and for making decisions about individual planning applications. This includes planning staff and their colleagues in local authorities.

The guidance in this document will help those who value and care for this area to ensure that future developments contribute to the sense of place.

## 1.4 Status of this guidance

This document has been produced to help implement the Malvern Hills AONB Management Plan which 'formulates local authority policy for the management of the AONB and for the carrying out of their functions in relation to it' (Section 89 of the Countryside and Rights of Way Act 2000). The AONB Management Plan is a material consideration in relation to planning, and is referenced in Local Development Plans for the area. This guidance amplifies the content of the Management Plan in relation to development in the AONB.

Using this document will help public bodies to meet their statutory duties to have regard to the purposes of conserving and enhancing the natural beauty of the AONB in exercising or performing any functions in relation to, or so as to affect AONB land (Section 85 of the Countryside and Rights of Way Act 2000). Its use will also help to ensure that 'great weight' is given to the conservation and enhancement of landscape and scenic beauty in the AONB, as required by the National Planning Policy Framework.

## 1.5 A word on methodology

The guidance contained in this document is based on the principle that colour is never seen in isolation from its setting. Selecting colours for building materials has to take account of the site context if good choices are to be made. Indigenous site colours throughout different parts of the AONB have been documented, analysed, and synthesised into 'existing palettes' which represent the essential colours that belong to those areas. Working with these palettes it has been possible to create 'developed palettes' of colour appropriate to a range of building materials, which will help to integrate new development into the landscape.

This process of analysis and design is known as Environmental Colour Assessment. It presents a logical approach to a subject which many people regard as a matter of taste, and therefore beyond objectivity. However, this process creates a robust insight into the colours of specific places, creating developed palettes from which people can still exercise preferences for particular colours, but in the knowledge that these colours will work with the site.

The Environmental Colour Assessment that underpins this guidance was undertaken in the winter months of 2015 /16, and therefore clearly reflects the seasonal colours prevalent at that time. However, winter is an advantageous time of year to make the study. Foliage and the play of light and shade on leaf canopies do not distract the eye or screen new interventions as they may in the summer and the winter landscape is at its most exposed and elemental. It should also be recognised that that whilst the incidence, proportions and visibility of colour will vary through the seasons there is a consistency of colours present throughout the year. Therefore, colours selected from a winter palette will always be relevant.

<sup>1</sup> The document may also be of use in helping to inform colour choice for development outside of the AONB boundary. However, it must be stressed that baseline survey work has not been undertaken outside of the AONB and therefore the specific colour palettes in this document should be subject to verification in the field before being used in this wider area. The principles of exterior colour design (pages 5-7) are relevant outside and inside the boundary.

<sup>2</sup> As above.

## 2 How to use this guide

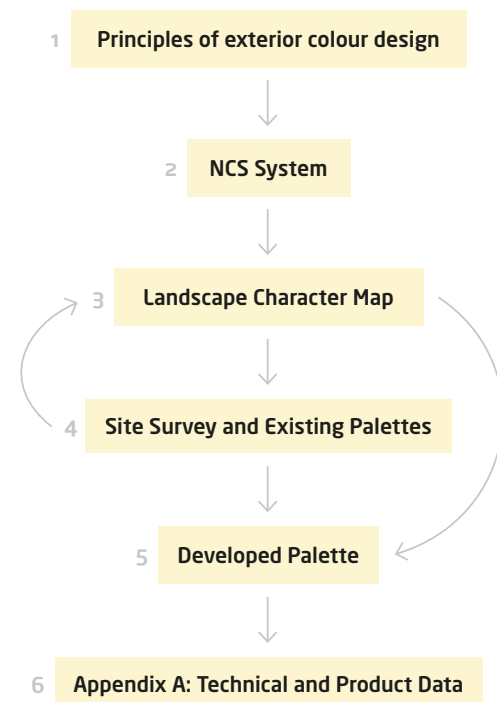

### 2.1 Step 1: Read the 'Principles of exterior colour design' notes

Working through the questions will make you aware of what to look out for and help you to decide what you want to achieve with the colour design.

### 2.2 Step 2: Familiarise yourself with the Natural Colour System (NCS)

It is not essential to be an expert in its application but a basic knowledge will help you to understand colour terminology and how to communicate your ideas. See page 9 of this document and [www.ncscolour.co.uk](http://www.ncscolour.co.uk)

### 2.3 Step 3: Locate your development site on the Landscape Character Map (on page 2)

A more detailed version of this map is available as part of a web-based tool which allows people to search the guidance by postcode. This is available through the Malvern Hills AONB website: [www.malvernhillsaonb.org.uk/management/guidance](http://www.malvernhillsaonb.org.uk/management/guidance)

### 2.4 Step 4: Examine the Existing Palette and associated site survey photographs for the relevant Landscape Character Type or settlement

This will help you to understand the provenance of the selected colours. If possible walk the area, take in views to your site from outside of the area and pay close attention to the colours you see. You may decide at this stage to review your decision at Step 3 and also include additional Landscape Character Types because of their visual connection to your site.

### 2.5 Step 5: Examine the relevant Developed Palette(s) for your development site

**a)** Identify the relevant material within the groups on the left-hand side of the palette. These groups contain horizontal rows of eight colours each. It is from one of these that you will select your colour scheme.

**b)** Select one colour from the first set of three columns (labelled INTEGRATION A, B, C) within your chosen group. These colours are used to integrate prominent elevations into the landscape. Use for main walls. Integration colours can also be used for roofing if this is a prominent feature of your design.

**c)** Read across to the right on the same row. The next two colours are a neutral grey and a tinted (coloured) grey.

Choose a grey to create a transition in your building frontage, e.g. between an original building and a contemporary extension, if this is needed. The neutral grey has a close tonal relationship with the selected integration colour. If you cannot find your preferred building material in the precise integration colour you have selected then use the tonality of the neutral grey to help choose another colour of the same tone.

**d)** Select one colour from the second set of three columns. These are accent colours, used for details such as windows and doors etc. They are paired with the integration colours A-A, B-B, C-C. These pairings are recommended, however another accent colour from within the the building material group may be preferred. These colours tend to be either lighter or more intense than the integration colours, and should be used sparingly.

### 2.6 Step 6: Refer to Appendix A for product information on a range of building materials suitable for your development

The majority of the products listed are formulated using the NCS colour system, aiding reliable colour outcomes from elevation to finished building. In the event that you cannot get the exact colour selected from the palette, then look for the closest match. The list of products is representative only, providing general guidance and not strict specification.

	INTEGRATION			NEUTRAL	TINT	CONTRAST ACCENT		
RENDER, MASONRY PAINT	A	B	C			A	B	C
	S 0502-Y50R	S 0505-Y20R	S 1005-Y20R	S 0500-N	S 0502-Y	S 1502-G	S 1505-Y20R	S 2005-Y20R
	S 2005-Y20R	S 3010-Y	S 4010-Y10R	S 3000-N	S 3502-Y	S 1005-Y20R	S 1010-Y	S 2010-G90Y



## 3 Principles of exterior colour design

Colour guidance for development within the AONB is aimed at integrating new buildings into the landscape in a way that benefits both the landscape and the built form. This can range from effectively camouflaging or minimising the visual appearance of a utilitarian building to emphasising the specific qualities of a place through the architecture, expressed in colour, form and massing.

Good colour choices depend on a good understanding of the proposed development in relation to its landscape setting. The following checklist gives an idea of the issues involved.

### 3.1 Is the development 'background architecture' or 'signature architecture'?

Small scale domestic development, village expansion, and developments associated with farming and rural industries will often be designed to fit within the grain, colour and texture of the local environment. Signature buildings may have a presence and scale which allows a more dynamic use of colour and materials, interacting with, and complementing the landscape setting, but also standing out against it.

The guidance contained in this document deals primarily with the former type of development. If your scheme is of the latter type then you may wish to extend the relevant developed palette into more complementary or accented colours, or a different range of materials.

### 3.2 Where are the key views to the development?

It is necessary to anticipate the key viewpoints from which the completed development will be seen. Some viewpoints may be



Highly reflective roofing material

more sensitive than others and require an approach with colour which minimises the impact of the building, whilst others may require a stronger approach to aid the legibility of the scheme.

### 3.3 From what distance will the development be seen?

Whilst the nature of hue alters with distance, tonal contrasts between built form and landscape remain largely constant. Therefore if a development will be visible from afar, and the intention is to 'lose' it in the landscape then the tonal qualities of the colour rather than the hue of the colour become particularly important. In this case it will be preferable to select tones which match or are slightly darker than the landscape when seen from a view point. If the intention is to create a landmark in the distance, then select much lighter tones than are present in the landscape.

### 3.4 Is light reflectivity an issue?

Sunlight striking a surface can substantially alter the perceived colour making it both lighter and brighter in the landscape. South-facing elevations and inclined roofs will be particularly prone to this effect.

Among the common building materials, paint finished steel can be highly reflective. It is possible to find some matt finishes to paint work in different colours, or to find alternative materials such as fibre cement. If there is no realistic alternative to steel then select a dark tone for roofing material as these reflect less light than a light coloured sheet. Slates are another material where sheen can be problematic. Natural slate will weather back to a matt finish with some colour variations, however, man-made equivalents tend to remain consistent in colour and sheen for longer.





Colwall from Chances Pitch

As a general rule matt integration colours will sit better in a rural context allowing for patterns of light and shade to animate surfaces. Matt finishes are particularly important when considering development which sits in important views, especially from above. North facing elevations will remain in the shade and potentially will remain wetter for longer. If the material is affected by rain, such as lime wash or timber, its perceived colour will be darker and the hue may also shift when wet.

### 3.5 What is the key landscape context within the visual frame of the development?

The colour palettes in this guidance have been set out according to the Landscape Character Type (LCT) categorisations which exist for the area. However, due to the often undulating topography of the AONB, only considering the LCT within which the development site sits may not provide the full information needed to appraise the visual context. This is particularly significant for developments on the margins of LCTs, where rising ground or woodland plantations, located within

a different character type actually provide a more significant backdrop. Thoroughly analysing the site before referring to the palettes will help to ensure colour selection from the appropriate group.

### 3.6 Does the building form require articulation to aid legibility or to influence scale?

Introducing a different colour or material can help 'guide' people around a building, making its use more intuitive. If the scale of a building looks too large for its setting, introducing another colour of a dark recessive nature will help to diminish the apparent scale of the building, by breaking up its massing.

A general rule of thumb is to only introduce a change of colour / material, where it makes sense to do so, eg. for recessed or projecting panels, or where there are legibility or structural reasons. In general the more three dimensional elevations appear, the more interesting they are, on the other hand too many colours can make a building appear fussy and confused.

### 3.7 Does the development address textures occurring within its landscape?

Colour and material choices also need to be informed by the background texture of the landscape setting. This requires analysing adjacent building materials, and vernacular detailing, and also the dominant vegetation and ground finishes to understand the depth of relief, play of light and shade and range of tactile surfaces. These observations will help determine appropriate finishes and textures for the development.

### 3.8 Are the materials colour-fast? How will they weather?

High chromaticness in dark colours especially reds often results in fading under UV light. Natural materials like timber will also fade and this needs to be anticipated before specification. Whilst there is often a reluctance to stain newly constructed timber cladding it should be recognised that the same cladding will look quite different after a few summers.



### 3.9 What is the effect of distance on colour?

Research shows that the perceived colour of a building façade, seen from some distance, tends to look less dark and more chromatic or brighter than the inherent colours of the construction material. In other words a colour sample which may look slightly dull in the studio as a swatch will look more colourful and lighter on the façade.

The developed colour palettes in this guidance have been largely adjusted from the existing palettes to take account of this with a low level of chromaticness, and an increase in blackness. This quality of 'blackness' is of great importance as this represents the tone or nuance of a colour. The effect of tone on the visibility of a building against a distant landscape has been referred to above. The difference in tone between a building and its surroundings is probably the most important factor contributing to recognition of its form.



The effect of distance on colour

Hues can also change with distance. Perceived colours are often lighter and brighter than samples, with the exception of greens and yellows which tend towards blue when seen from a distance. In a study carried out in Sweden on this phenomenon, green close up became darker blue green at 2km and lilac grey at 20km.

All natural green inherent colours have some yellowness in them though this does vary with seasonality and land management. If a developer wishes to use green on a development, and for it to appear green at a distance, then a green with a higher degree of yellow will be needed.

Assumptions are frequently made that the only suitable colour for developments in rural areas, especially large scale industrial and agricultural developments is green. However many of the greens available as standard colours in suppliers' ranges do not contain enough yellow and black and the result is a glaring mismatch with the surroundings. This reinforces the point that tonality or nuance is all-important, especially when it is difficult to get the right hue.

### 3.10 A word on white

White S 0300-N, S 0500-N is commonly used on many building types. It will coordinate with all colours as it is neutral and contains no colour in its own right. It is acceptable to use white on developments where white is characteristic and contributes to local distinctiveness in the vicinity, for example in some of the settlements to west and east of the Malvern Hills ridge line or in the timber infill houses of the Principal Timbered Farmlands.

However, the range of commercial off-whites and creams is very wide and the developed palette sets out a selection of these colours (frequently found as masonry paint or render) which are derived from some of the of the surrounding landscape and therefore more likely to be appropriate in the locality, whilst retaining a resemblance to white. The same applies to the use of black S 9000-N.

### 3.11 Is simultaneous contrast an issue?

Simultaneous contrast occurs when the same colours look different when viewed against different backgrounds. In attempting to distinguish the colour against the background, the human eye tends to reinforce and exaggerate that difference. In reality this is more difficult to observe against a polychromatic background of shifting vegetation than it is against the controlled and hard surfaces of a building façade, and is more of an issue for the detailed articulation of a building. In addition, the seasonal variations which occur within a landscape mean that dramatic changes in background colour are relatively short lived and the perception of this phenomenon is more often altered by changing light conditions. Whilst it is useful to be aware of simultaneous contrast other factors are likely to be more influential within the realm of integrating development into the AONB.

Whatever colour choices are made, it is prudent to create a large sample to take to site before committing to full scale application. Examining a small sample under artificial light indoors can offer misleading information.

Overleaf are some images which illustrate good and bad practice in colour application and selection.



Use of white and black





Good colour mix for tiles, timber and brick. In keeping with the Unenclosed Commons Landscape Character Type



Soft, harmonising colours containing a lot of grey with weathered timber and silver birch working well together



Partly right, partly wrong: light coloured doors and too many materials



Colours much too light with no attempt to relate to wooded background



# Introduction to NCS

In order to accurately communicate the colours we see, we need a reference or notation system with the ability to pinpoint precise colour.

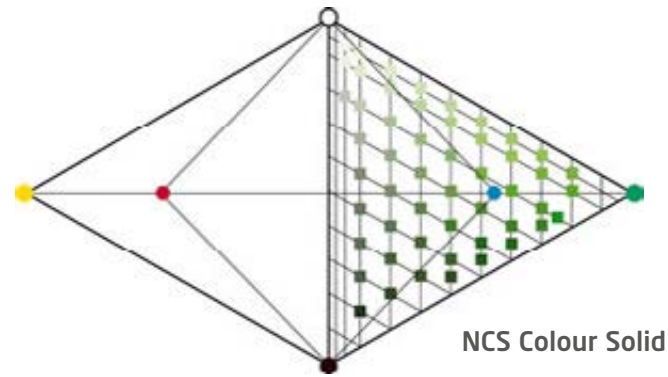

NCS Colour Solid

Six Elementary Colours are the basis for the Natural Colour System. These are White, Black, Yellow, Red, Blue and Green. The colours are shown below on the three dimensional model called the NCS Colour Solid. Every colour in the Natural Colour System is contained within the NCS Colour Solid, and can be described in terms of the six Elementary Colours.

In order to more easily pinpoint colours within the NCS Colour Solid, the NCS Colour Circle and NCS Colour Triangle are used.

The NCS Colour Circle is a horizontal slice through the NCS Colour Solid, and shows a progression from Yellow to Red to Blue to Green and back round to Yellow in 10% steps.

All the colours in the NCS System have a percentage of Whiteness or Blackness, and this is best illustrated using the NCS Colour Triangle. The NCS Colour Triangle is a vertical slice through the NCS Colour Solid. C stands for maximum colour intensity or Chromaticness, W stands for White and S for Black. The scales for Chromaticness, Whiteness and Blackness are each divided into one hundred parts which can be interpreted as percentages.

The NCS Colour Triangle and the NCS Colour Circle are used to pinpoint colours within the NCS System. The diagram (top right) pinpoints a colour with 30% Blackness and 20% Chromaticness, with a location on the NCS Colour Circle of G30Y. The complete NCS Colour Notation is S 3020-G30Y.

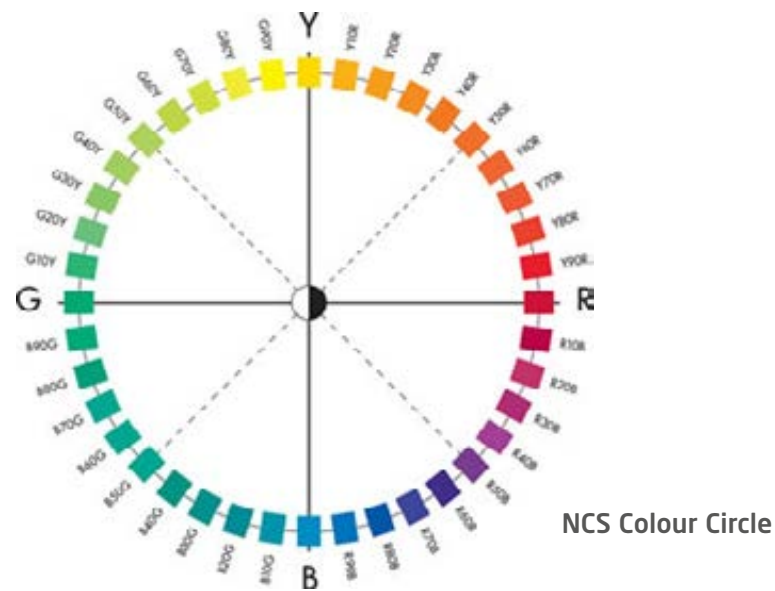

NCS Colour Circle

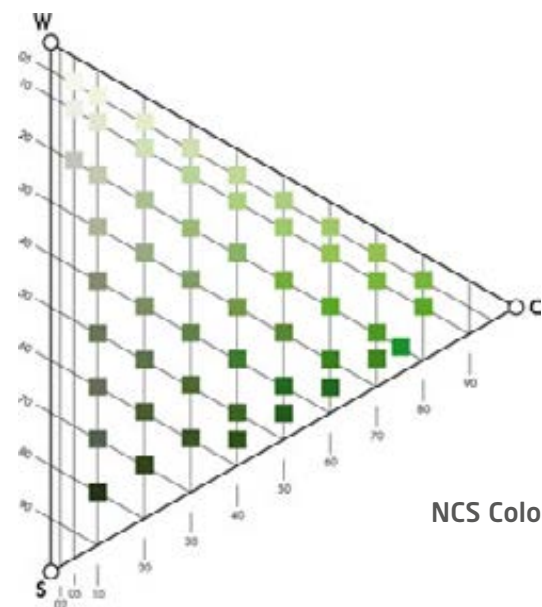

NCS Colour Triangle

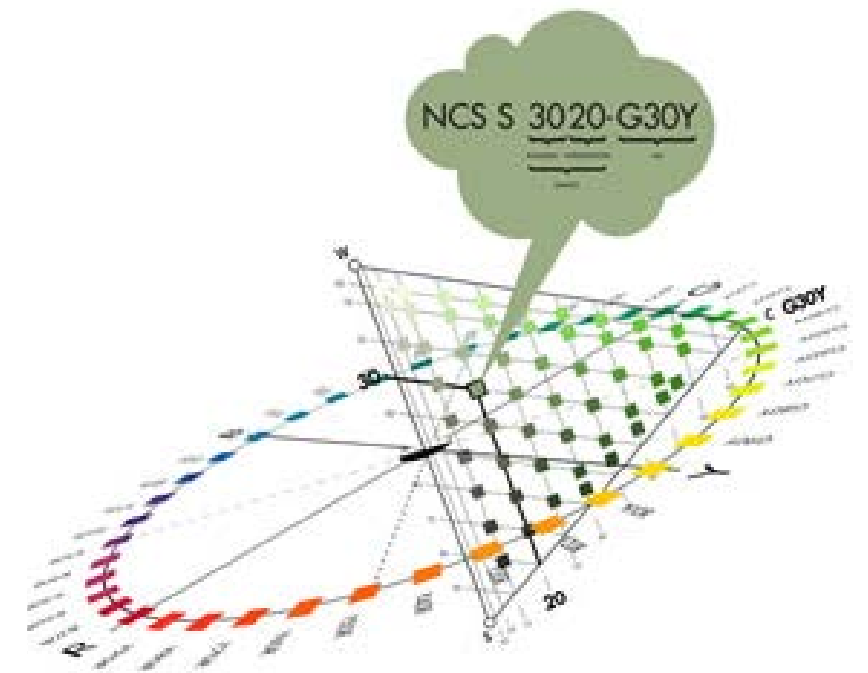

Using the NCS Colour Notation it is easy to define the appearance of a colour. In this notation (below) 3020 indicates the Nuance of the colour. The Nuance describes the relationship of the colour to Black (S) and to maximum colour intensity or Chromaticness (C). The Whiteness is determined as 50%, as the sum of the values of the three attributes (Chromaticness, Whiteness and Blackness) must always be 100%. The Hue, G30Y, describes the relationship of the colour to the Chromatic Elementary Colours, in this case G and Y. G30Y means Green with 30% Yellow. The letter S preceding the NCS notation means that the colour is from NCS Edition 2.

Achromatic colours (Black, White and Grey) lack Hue and are only given Nuance notations, followed by -N for neutral. S 0500-N is White and is followed by S 1000-N, S 1500-N, S 2000-N and so on to S 9000-N, which is Black.



NCS - Natural Colour System® property of and used on licence from NCS Colour AB, Stockholm 2016. References to NCS® in this publication are used with permission from NCS Colour AB. The colours might not exactly match original NCS colour samples. For original samples contact [www.ncscolour.co.uk](http://www.ncscolour.co.uk).





# High Hills and Slopes and Unenclosed Commons

p12



High Hills and Slopes

p15



Unenclosed Commons

p11



Developed palette

The developed palette on page 11 is built around the unimproved and unenclosed nature of acid heath and grassland present in both Landscape Character Types.

Lighter colours reflect the tussock forming grasses and scrub, rough grazing over thin soils, and grey reds of bracken and birch. Darker integration colours and their accent counterparts reflect the distant views to hilltops and the passing patterns of cloud over the landscape, lending blues, greys and lilacs to the range. Traditional brick colours, timber frame colours and hard Malvern stone colours are also represented in the palette.



# Developed palette

## How to read this palette

Identify the relevant material within the groups on the left-hand side of the palette. These groups contain horizontal rows of eight colours each. It is from one of these that you will select your colour scheme.

Select one colour from the first set of three columns (labelled INTEGRATION A, B, C) within your chosen group. These colours are used to integrate prominent elevations into the landscape. Use for main walls.

Integration colours can also be used for roofing if this is a prominent feature of your design.

Read across to the right on the same row. The next two colours are a neutral grey and a tinted (coloured) grey. Choose a grey to create a transition in your building frontage, e.g. between an original building and a contemporary extension, if this is needed. The neutral grey has a close tonal relationship with the selected integration colour. If you cannot find your preferred building material in the precise integration colour you have selected then use the tonality of the neutral grey to help choose another colour of the same tone.

Select one colour from the second set of three columns. These are accent colours, used for details such as windows and doors etc. They are paired with the integration colours A-A, B-B, C-C. These pairings are recommended, however another accent colour from within the the building material group may be preferred. These colours tend to be either lighter or more intense than the integration colours, and should be used sparingly.

	INTEGRATION			NEUTRAL	TINT	CONTRAST ACCENT		
RENDER, MASONRY PAINT	A S 2010-Y20R	B S 3005-Y20R	C S 2010-Y30R	S 2000-N	S 2002-Y	A S 2005-Y20R	B S 2005-G80Y	C S 2005-Y30R
	S 3010-G70Y	S 3020-Y40R	S 3020-Y	S 3000-N	S 3502-Y	S 2020-R70B	S 2010-G40Y	S 2502-Y
	S 4020-Y30R	S 4010-G90Y	S 4020-G70Y	S 4000-N	S 4502-G	S 3005-R20B	S 2010-G90Y	S 3005-G80Y
BRICK, STONE	S 3030-Y60R	S 4030-Y50R	S 4030-Y60R	S 4000-N	S 4502-Y	S 3005-B20G	S 3005-G50Y	S 2005-Y60R
	S 5010-Y50R	S 6005-Y20R	S 6005-Y80R	S 5500-N	S 5505-Y	S 3005-Y50R	S 2005-B20G	S 4005-G80Y
TIMBER, FIBRE CEMENT	S 5020-Y70R	S 6010-Y10R	S 7010-Y50R	S 5500-N	S 5502-Y	S 3010-G70Y	S 3502-B	S 4005-Y50R
	S 6010-Y50R	S 6010-R10B	S 6010-G90Y	S 6000-N	S 6502-R	S 4005-R50B	S 4502-R	S 4010-G90Y
METAL SHEET, SLATE	S 7005-R50B	S 7010-G90Y	S 7005-Y80R	S 7000-N	S 7502-R	S 5005-G50Y	S 5005-R80B	S 5005-Y80R
	S 7005-R80B	S 8005-Y20R	S 8005-Y80R	S 7500-N	S 7502-Y	S 5005-R50B	S 6005-B20G	S 6005-B80G

# High Hills and Slopes Existing palette



- colours appearing repeatedly in this Landscape Character Type

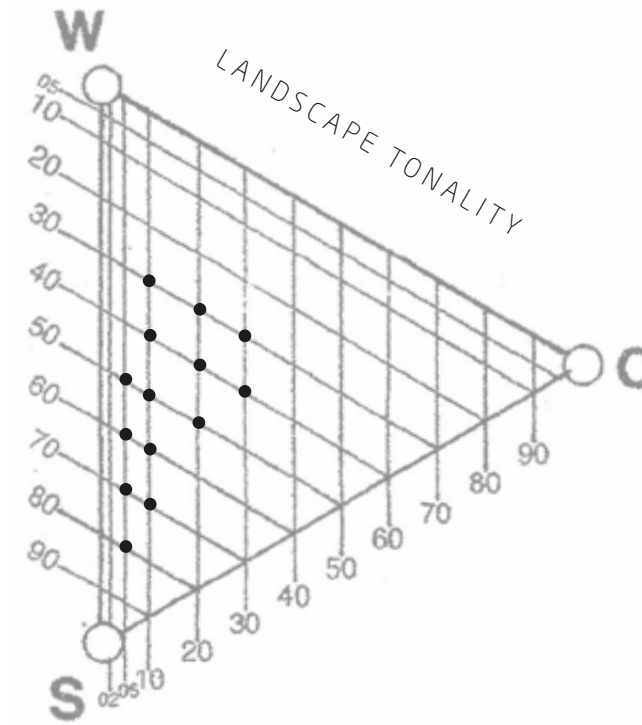

These triangular diagrams indicate the dominant tonalities recorded in this Landscape Character Area.

If you are unable to find a product which matches the colours set out in the developed palette, these diagrams indicate the acceptable range of tones which may be available in alternative colours.

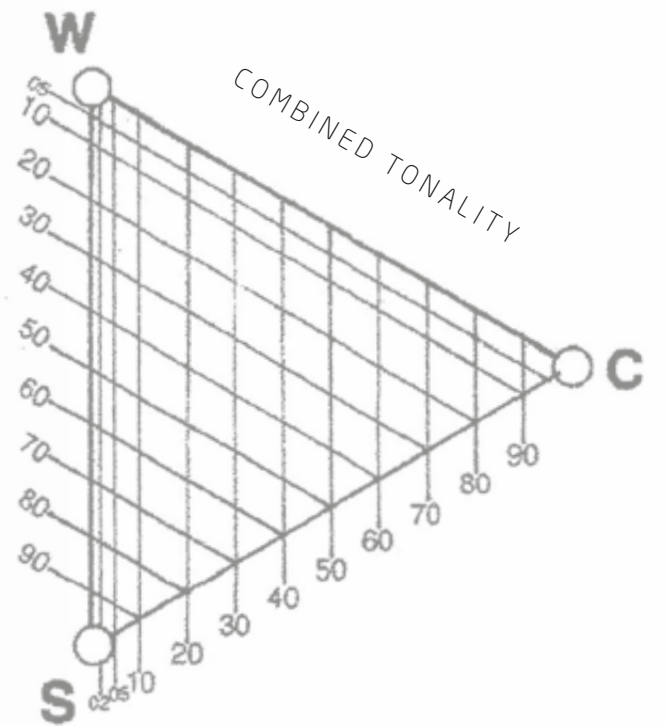
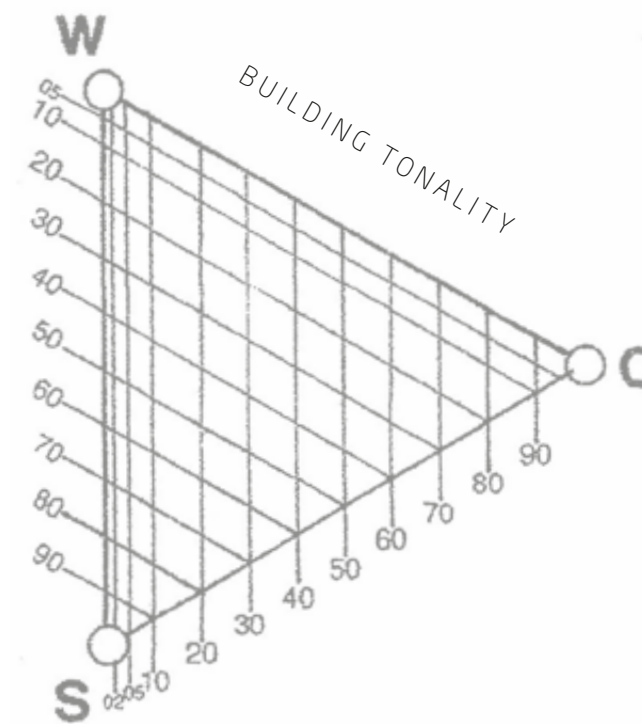



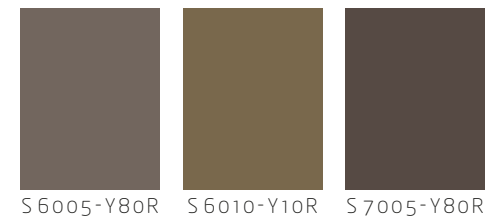
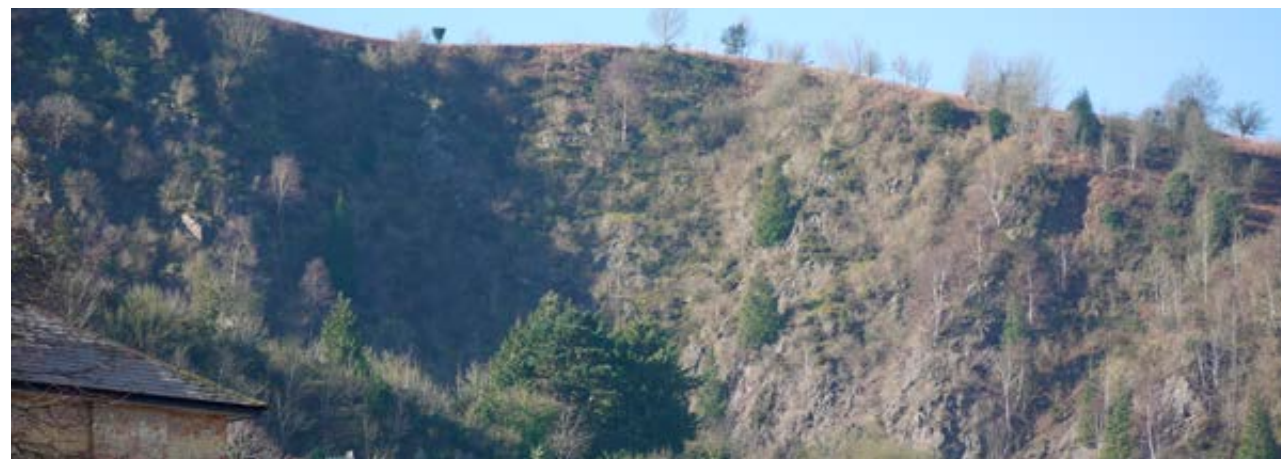
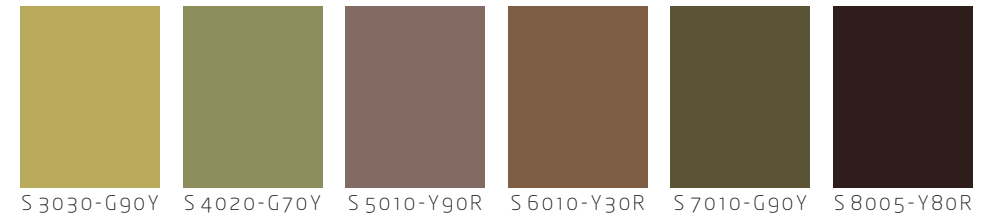
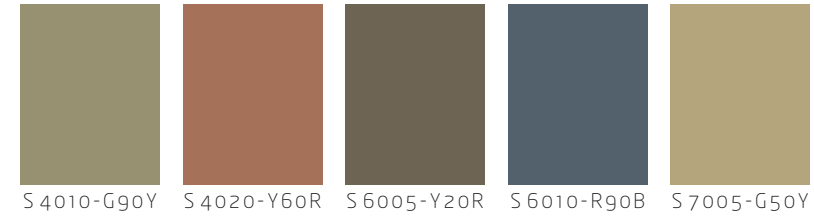
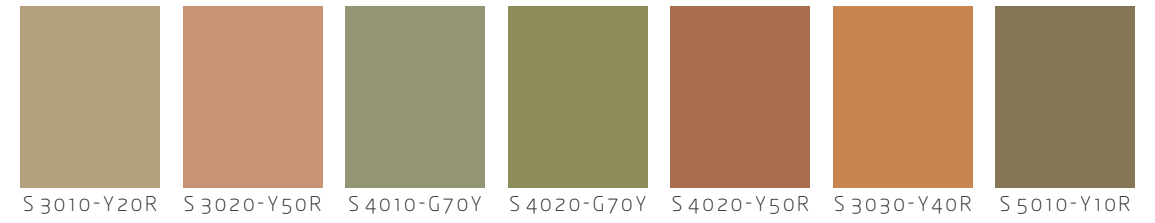



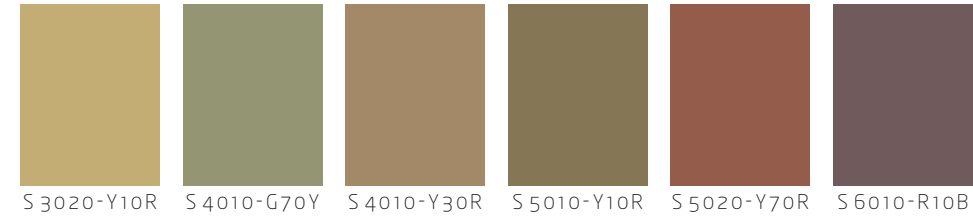
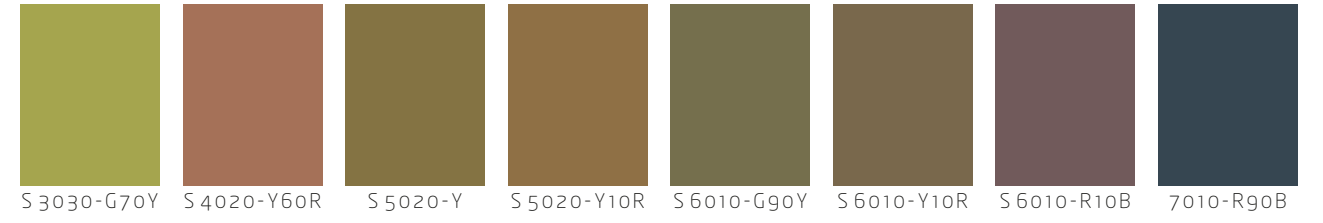
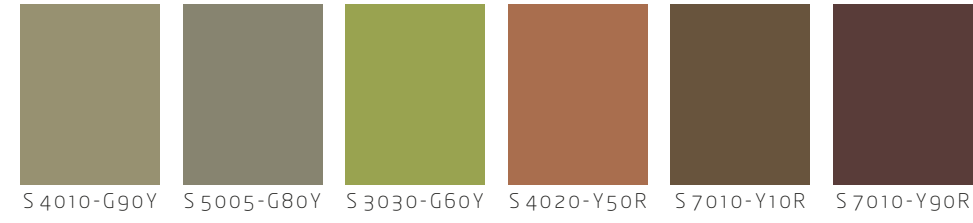
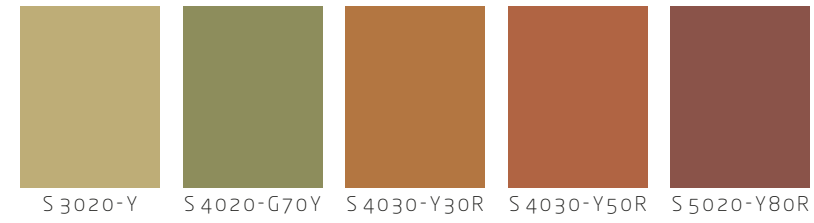



# Unenclosed Commons Existing palette



- colours appearing repeatedly in this Landscape Character Type

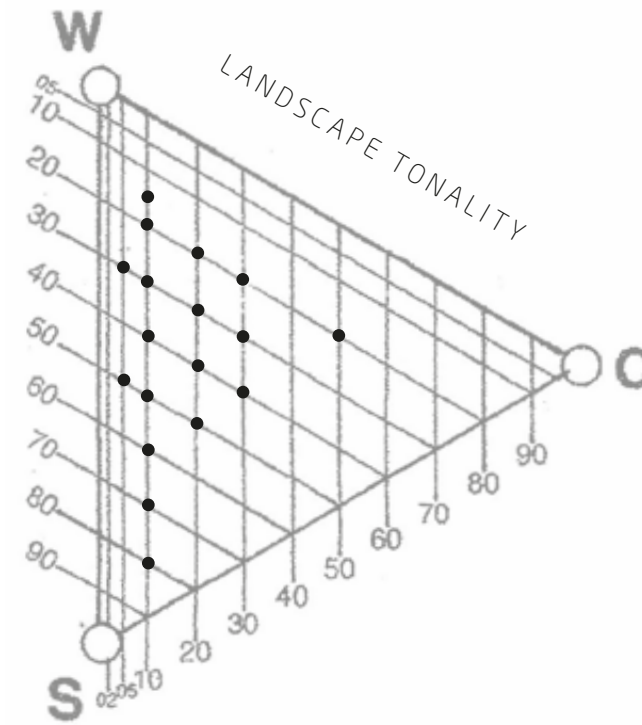

These triangular diagrams indicate the dominant tonalities recorded in this Landscape Character Area.

If you are unable to find a product which matches the colours set out in the developed palette, these diagrams indicate the acceptable range of tones which may be available in alternative colours.

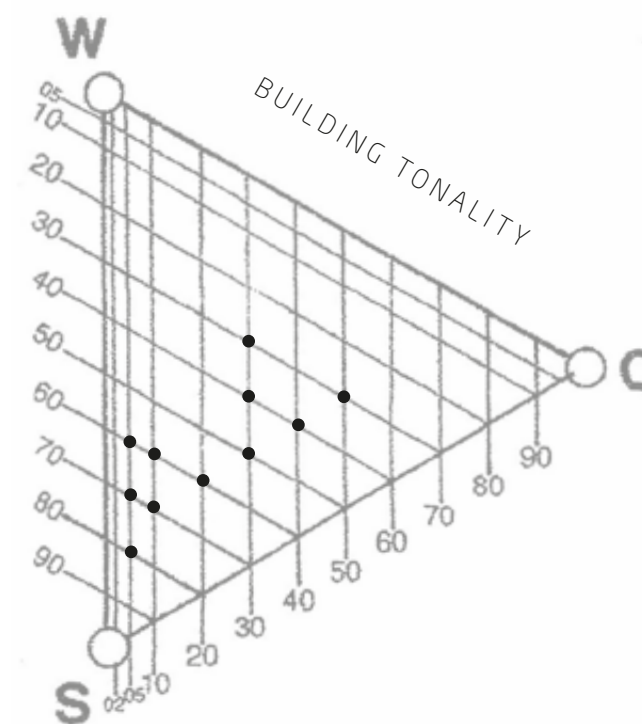
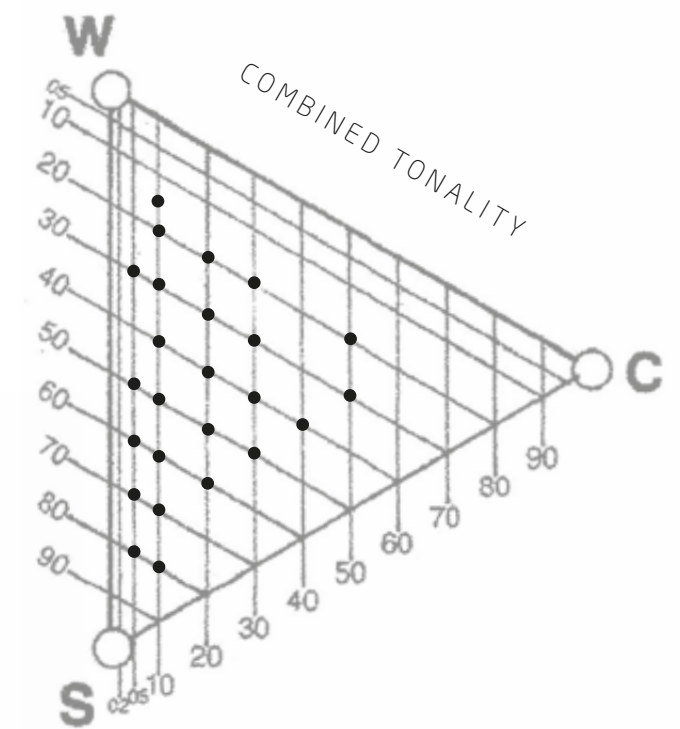

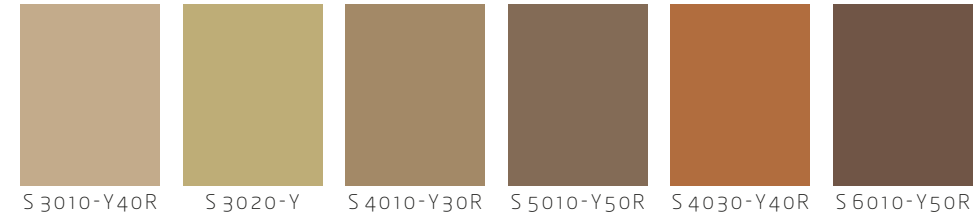
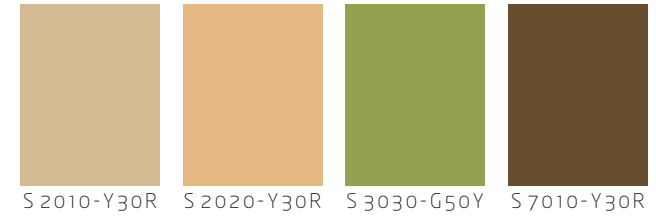
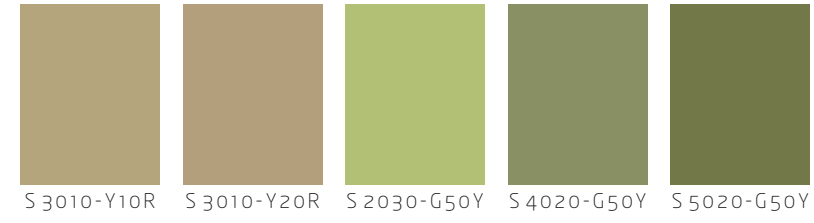
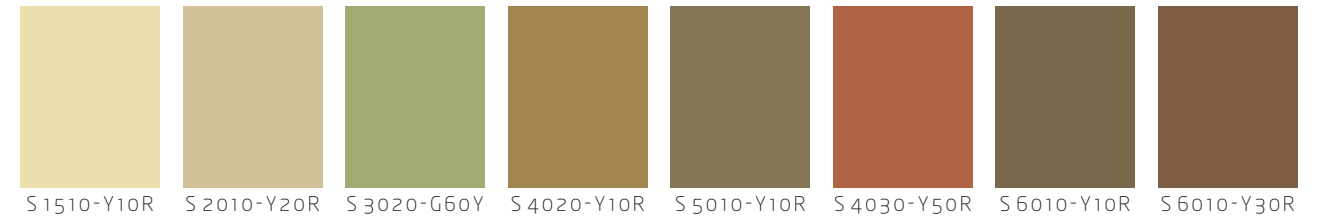



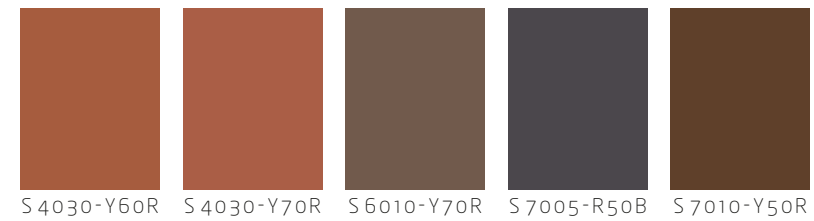
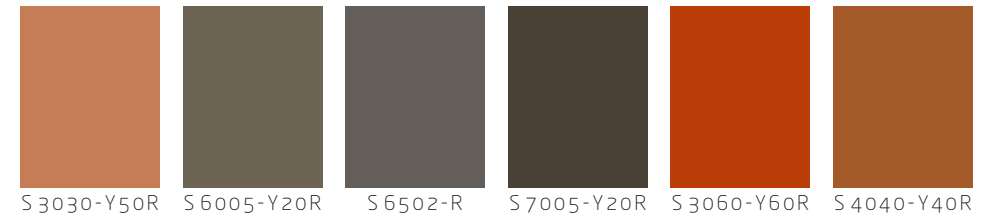
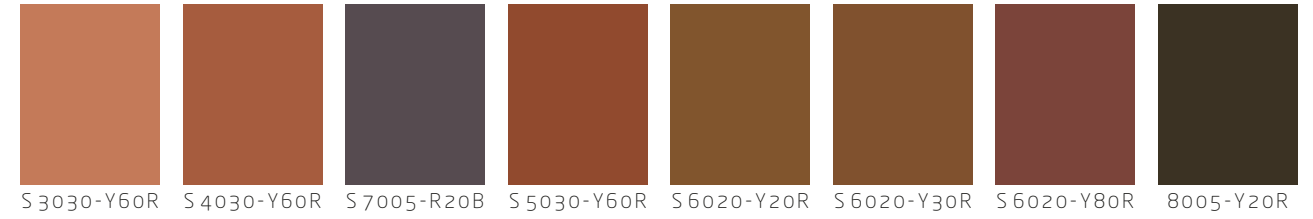
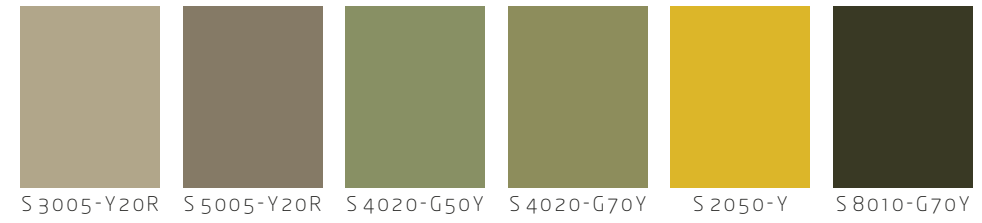



# Principal Wooded Hills, Principal Timbered Farmlands, Wooded Hills and Farmlands

p20

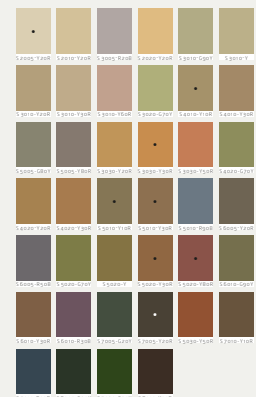

Principal Wooded Hills

p23



Principal Timbered Farmlands

p26



Wooded Hills and Farmlands

p19



Developed palette

The developed palette on page 19 reflects the common characteristics of these three Landscape Character Types. Woodland blocks, hedgerow trees and dense hedges, interspersed with tracts of farmland, some of it unimproved, outlined in places with intimate water courses, and narrow lanes.

The palette is built around the winter tones and hues of native trees, seen in block and silhouette, sometimes against a backdrop of evergreens but more typically against pasture. The colours derived from this are soft grey greens, green yellows and grey browns, with lighter colours derived from winter branches and harvested fields. The building materials of traditional buildings such as timber, brick and render can also be seen in this palette.



# Developed palette

## How to read this palette

Identify the relevant material within the groups on the left-hand side of the palette. These groups contain horizontal rows of eight colours each. It is from one of these that you will select your colour scheme.

Select one colour from the first set of three columns (labelled INTEGRATION A, B, C) within your chosen group. These colours are used to integrate prominent elevations into the landscape. Use for main walls.

Integration colours can also be used for roofing if this is a prominent feature of your design.

Read across to the right on the same row. The next two colours are a neutral grey and a tinted (coloured) grey. Choose a grey to create a transition in your building frontage, e.g. between an original building and a contemporary extension, if this is needed. The neutral grey has a close tonal relationship with the selected integration colour. If you cannot find your preferred building material in the precise integration colour you have selected then use the tonality of the neutral grey to help choose another colour of the same tone.

Select one colour from the second set of three columns. These are accent colours, used for details such as windows and doors etc. They are paired with the integration colours A-A, B-B, C-C. These pairings are recommended, however another accent colour from within the the building material group may be preferred. These colours tend to be either lighter or more intense than the integration colours, and should be used sparingly.

	INTEGRATION			NEUTRAL	TINT	CONTRAST ACCENT		
RENDER, MASONRY PAINT	A S 1010-G90Y	B S 2010-Y30R	C S 2020-Y20R	S 1500-N	S 1502-Y	A S 1010-Y	B S 1010-Y30R	C S 2010-Y20R
	S 3010-Y10R	S 3010-Y30R	S 4010-G70Y	S 3000-N	S 3502-Y	S 2005-B20G	S 2005-Y30R	S 2010-G70Y
	S 3010-G80Y	S 4010-G50Y	S 5005-G80Y	S 4000-N	S 4502-Y	S 3005-G80Y	S 4005-R50B	S 2005-R50B
BRICK, STONE	S 4020-Y30R	S 3030-Y50R	S 4030-Y50R	S 4000-N	S 4502-Y	S 3005-B20G	S 3005-Y50R	S 4010-Y50R
	S 5010-Y10R	S 4020-G90Y	S 6005-Y20R	S 5000-N	S 5502-Y	S 3005-G80Y	S 4005-Y80R	S 4005-G80Y
TIMBER, FIBRE CEMENT	S 6020-Y	S 6010-G70Y	S 5020-Y80R	S 5500-N	S 5502-Y	S 4010-Y10R	S 4005-Y50R	S 4005-B80G
	S 6010-Y90R	S 6010-Y30R	S 7005-Y20R	S 6000-N	S 6502-Y	S 4005-Y20R	S 4010-G70Y	S 5005-B20G
METAL SHEET	S 7010-G90Y	S 7020-Y20R	S 7010-Y10R	S 7000-N	S 7502-Y	S 5010-G90Y	S 5005-Y20R	S 5005-R80B
	S 8005-G20Y	S 8010-Y90R	S 8005-Y80R	S 8000-N	S 8502-Y	S 6005-Y80R	S 6005-G20Y	S 6005-G80Y

# Principal Wooded Hills Existing palette

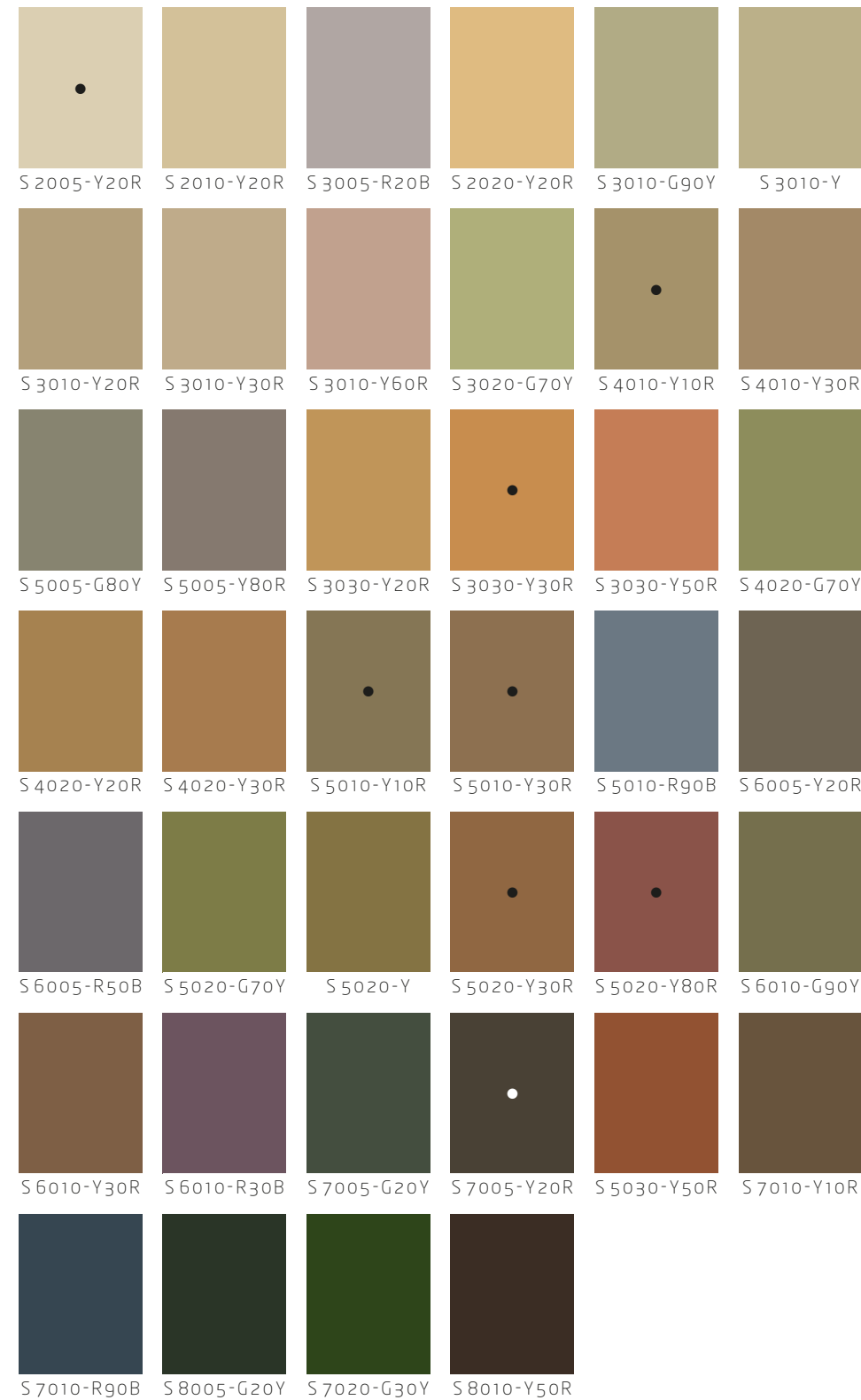

- colours appearing repeatedly in this Landscape Character Type

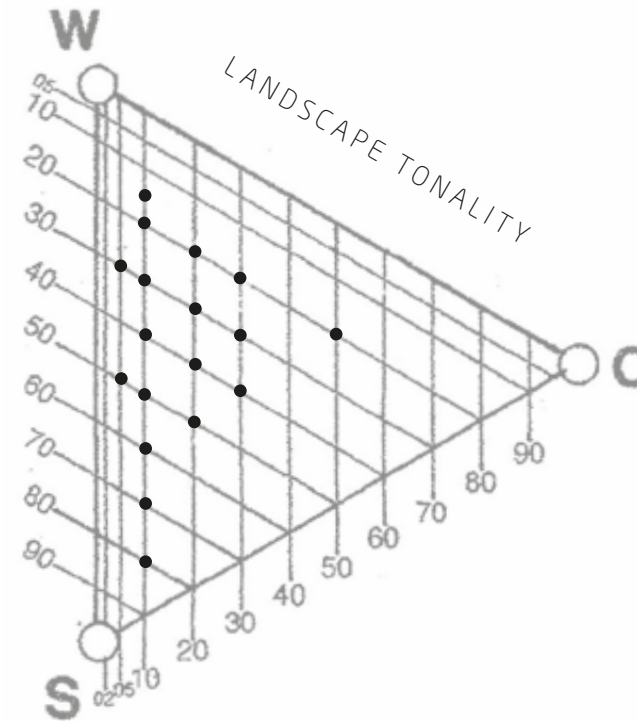

These triangular diagrams indicate the dominant tonalities recorded in this Landscape Character Area.

If you are unable to find a product which matches the colours set out in the developed palette, these diagrams indicate the acceptable range of tones which may be available in alternative colours.

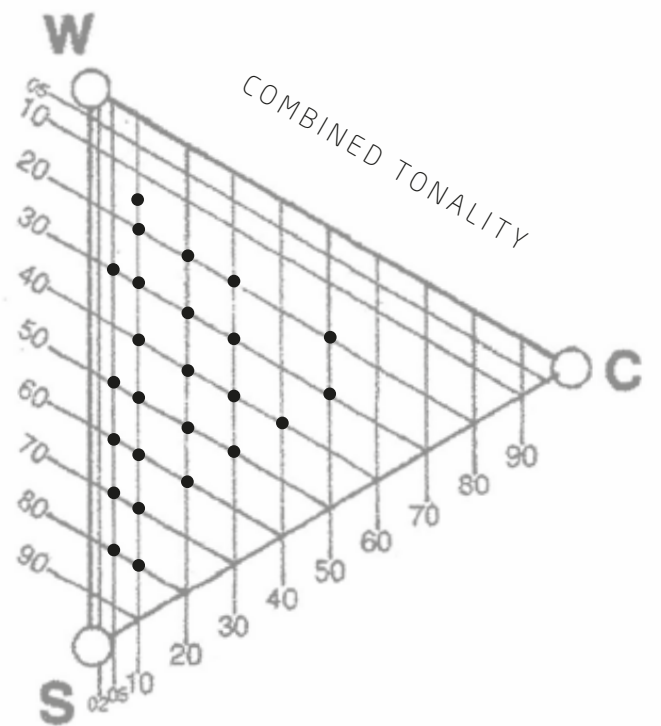
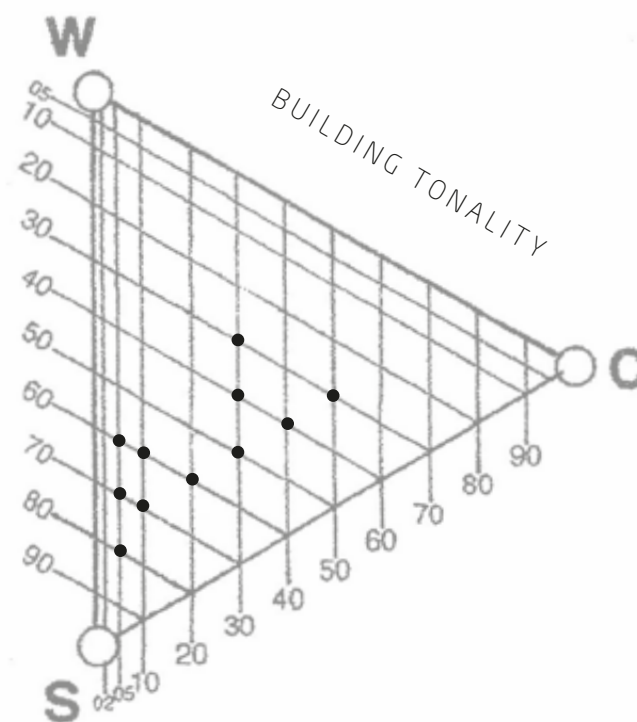



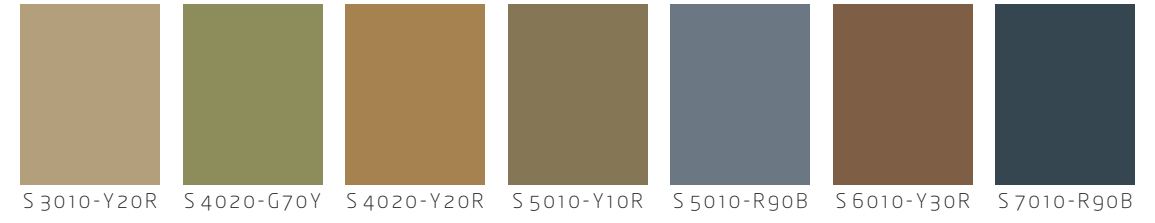
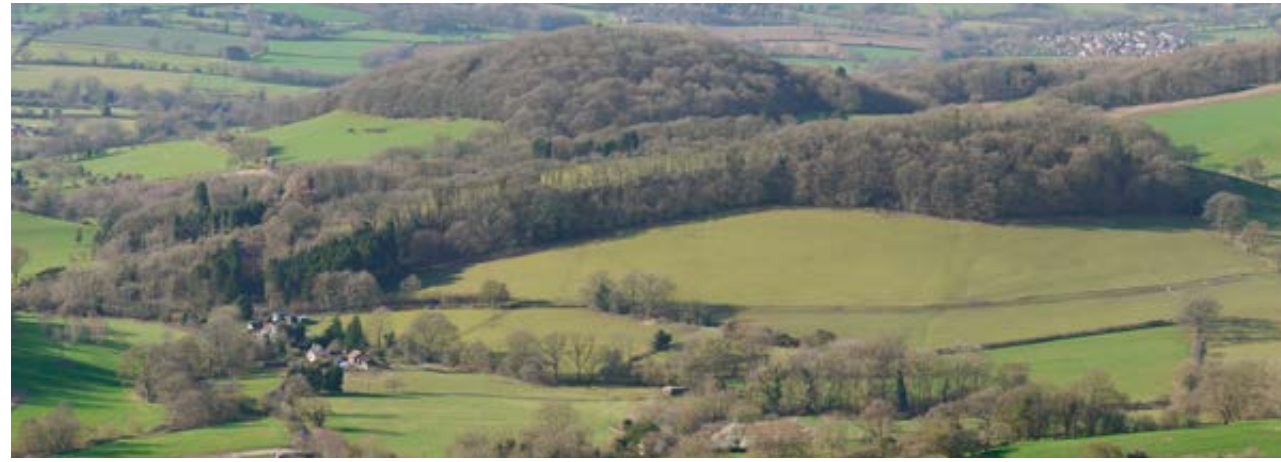
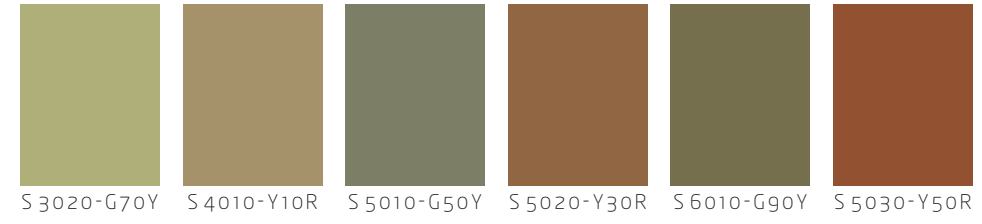



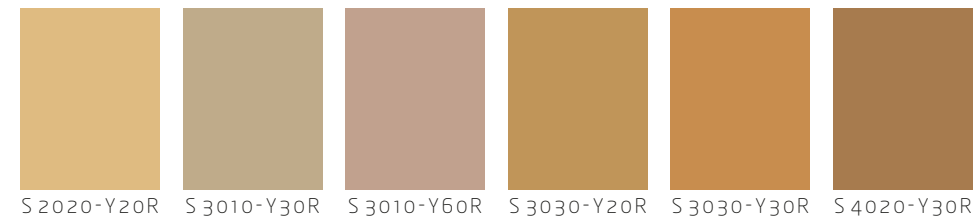
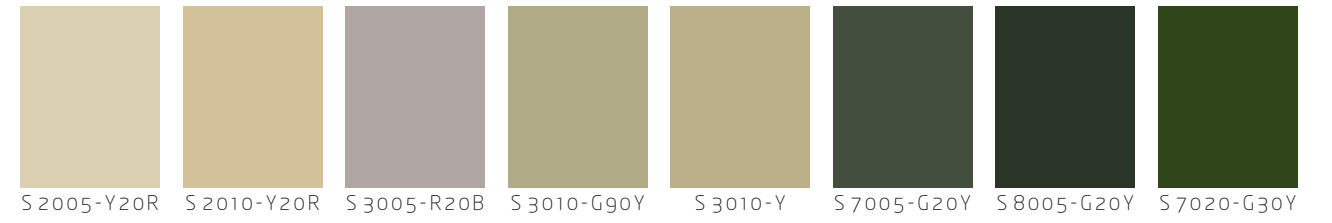
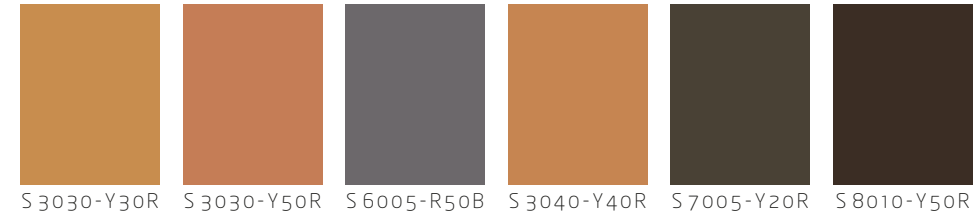
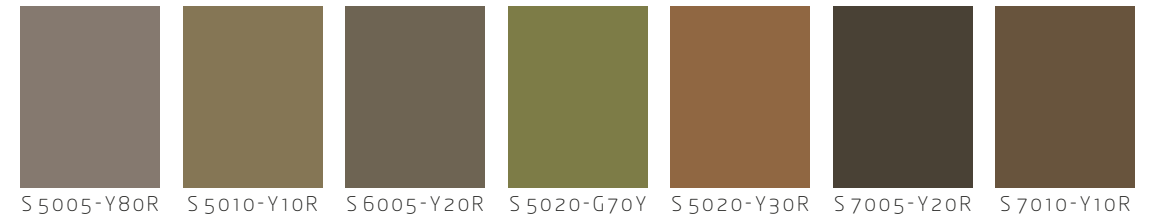



# Principal Timbered Farmlands Existing palette



- colours appearing repeatedly in this Landscape Character Type

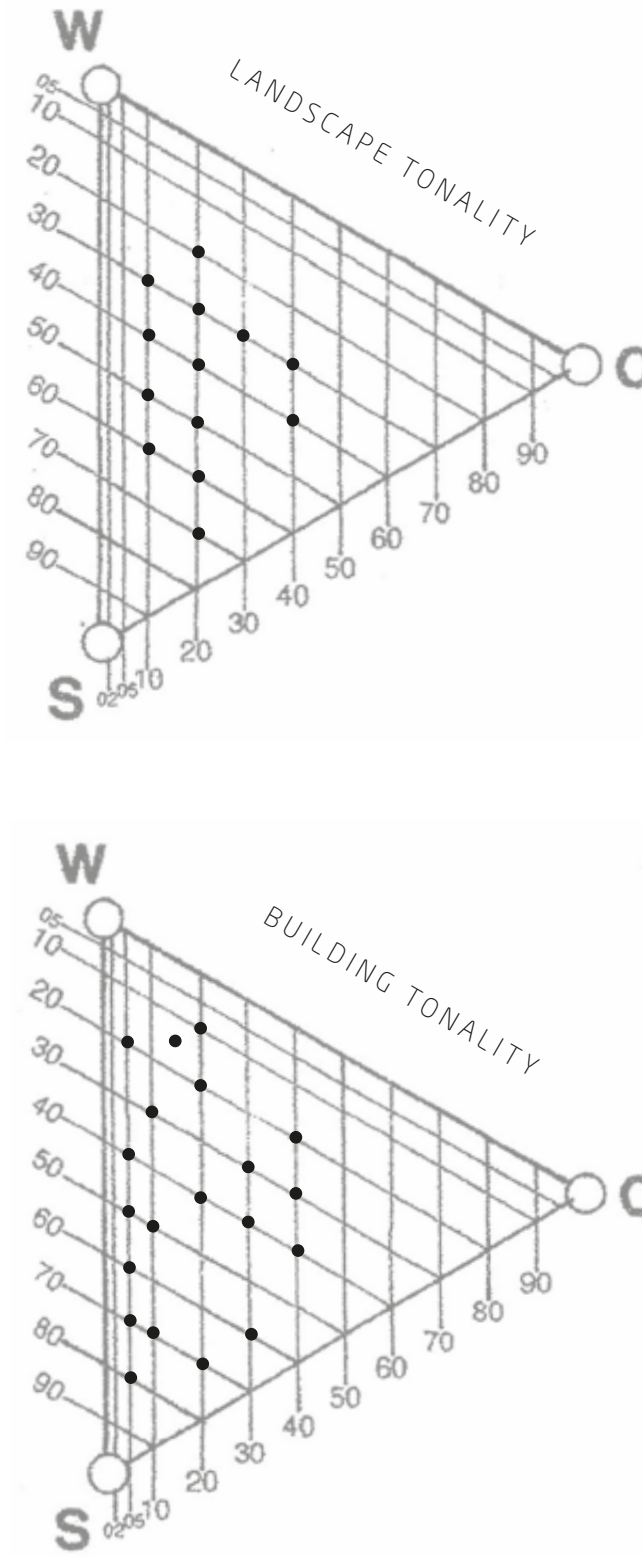

These triangular diagrams indicate the dominant tonalities recorded in this Landscape Character Area.

If you are unable to find a product which matches the colours set out in the developed palette, these diagrams indicate the acceptable range of tones which may be available in alternative colours.

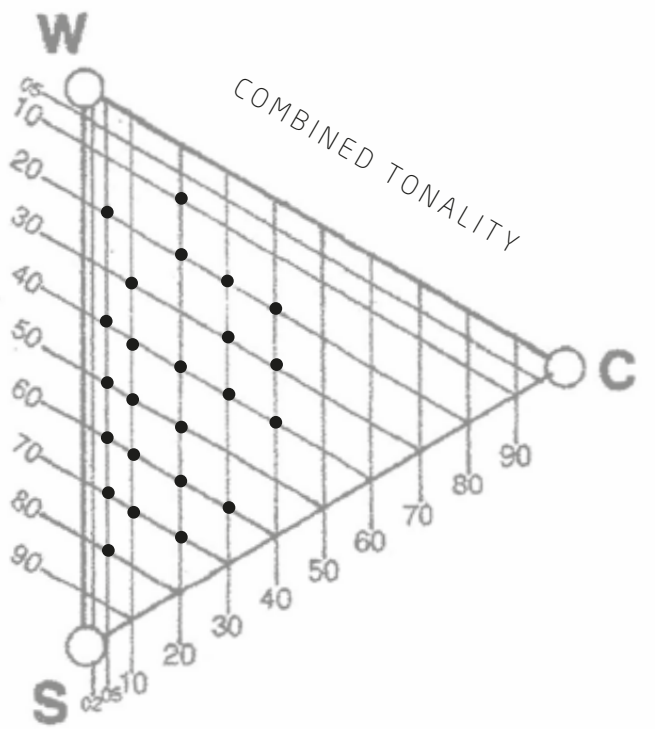

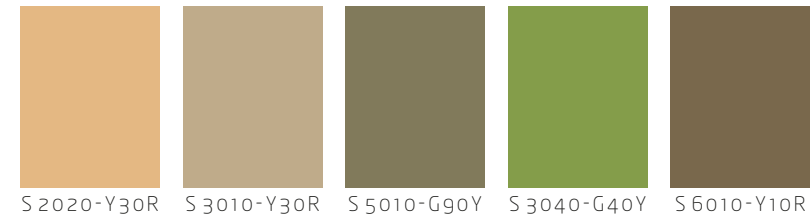
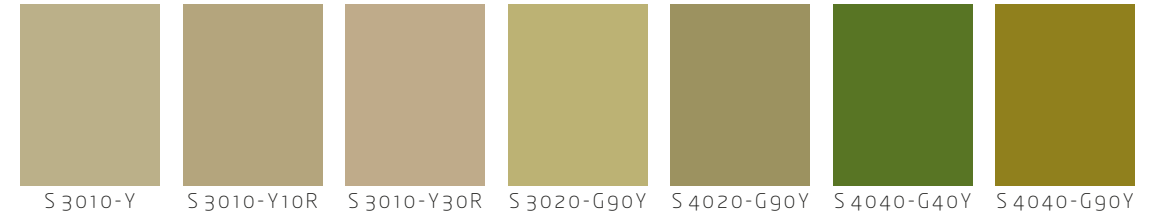
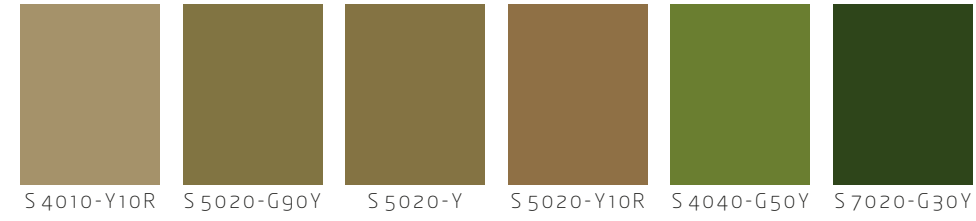
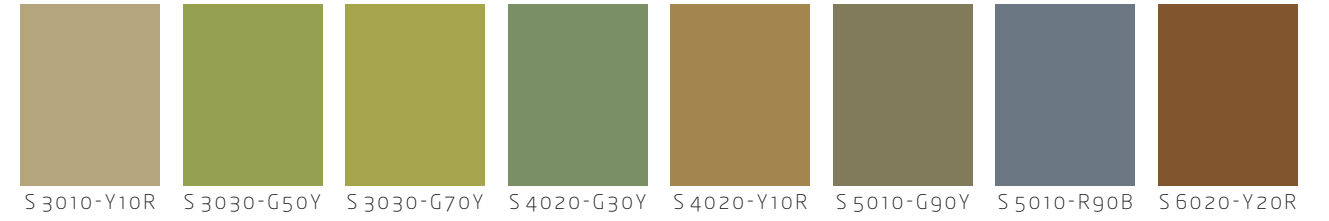



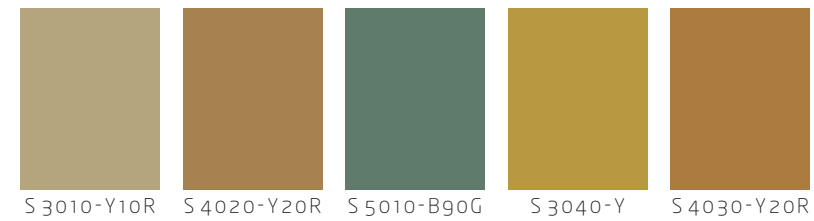
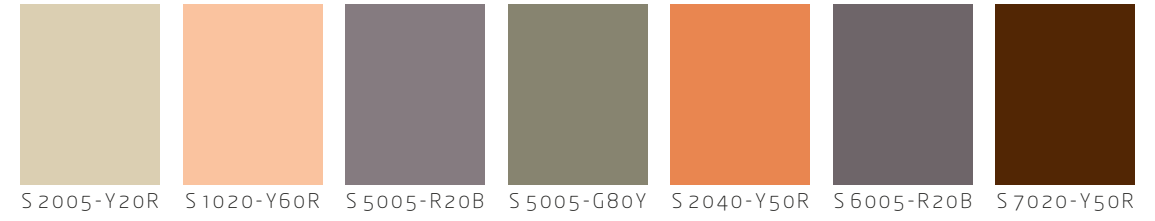
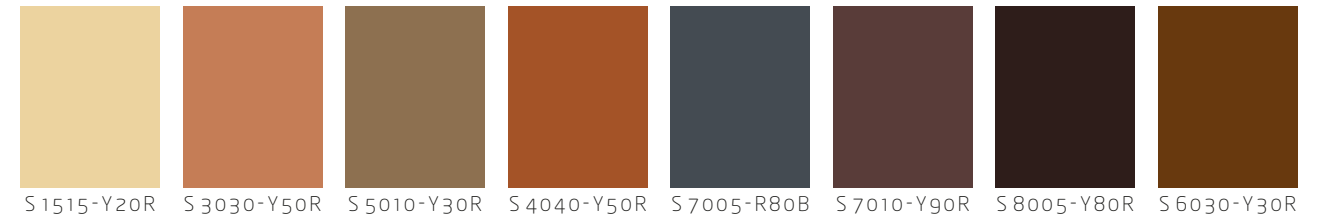

# Wooded Hills and Farmlands Existing palette



- colours appearing repeatedly in this Landscape Character Type

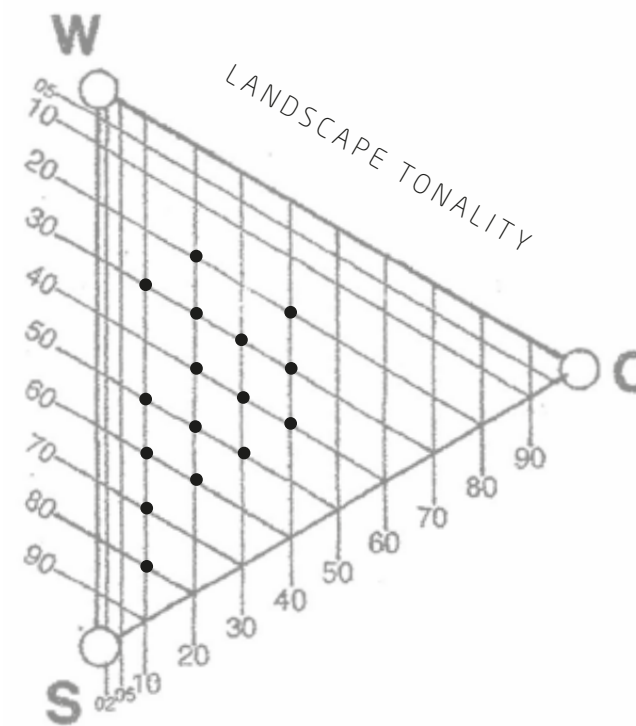

These triangular diagrams indicate the dominant tonalities recorded in this Landscape Character Area.

If you are unable to find a product which matches the colours set out in the developed palette, these diagrams indicate the acceptable range of tones which may be available in alternative colours.

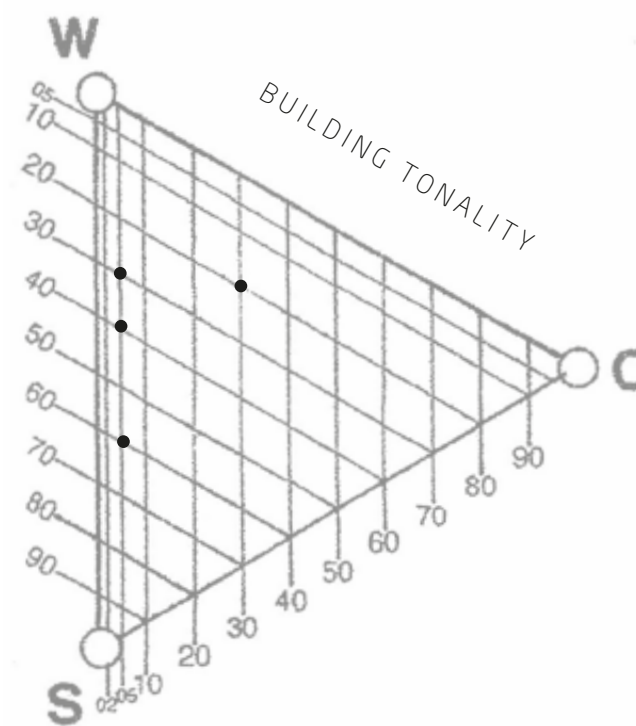
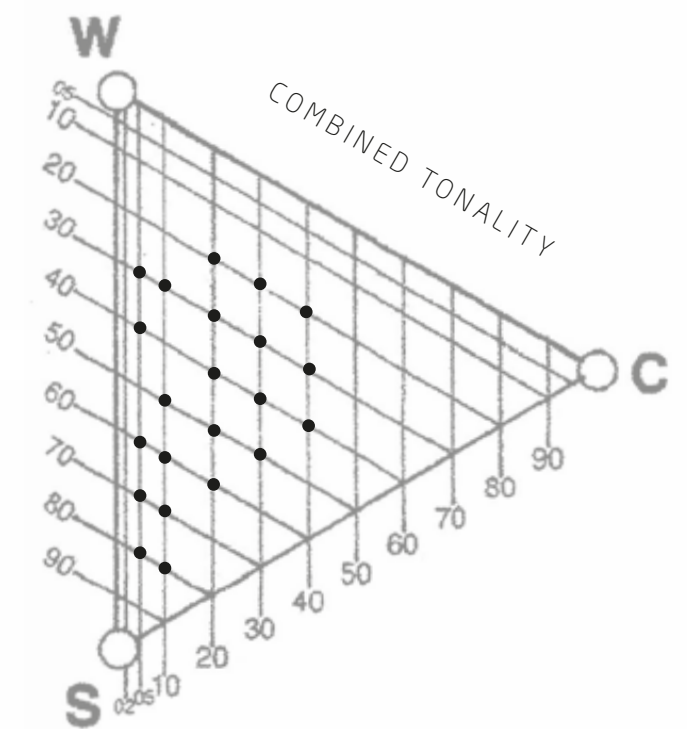



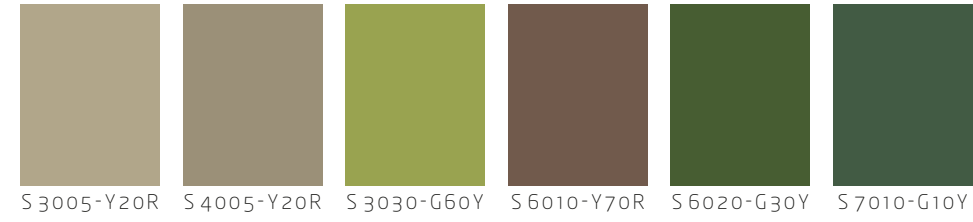
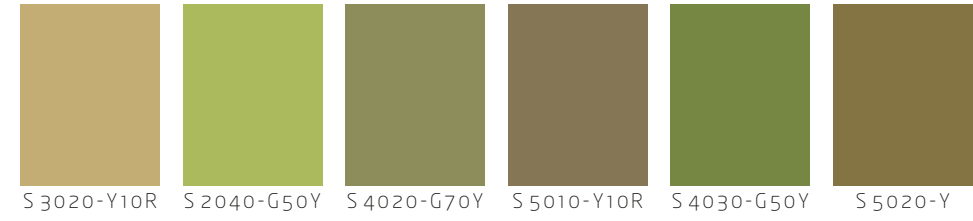
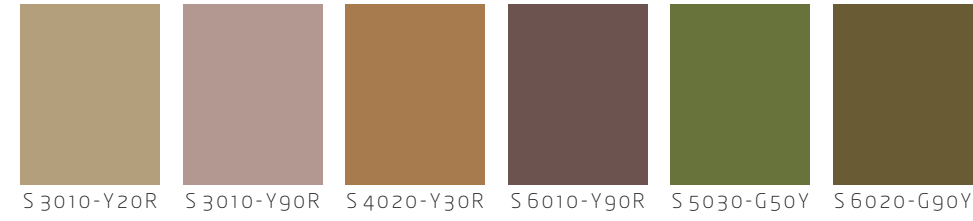

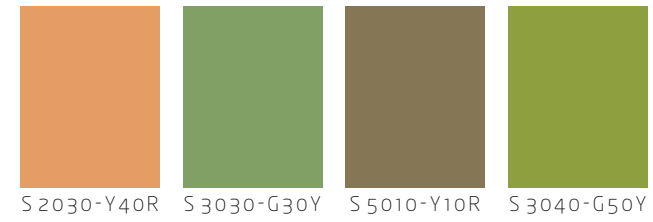
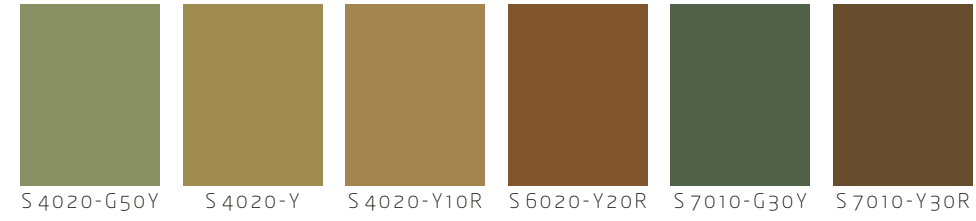
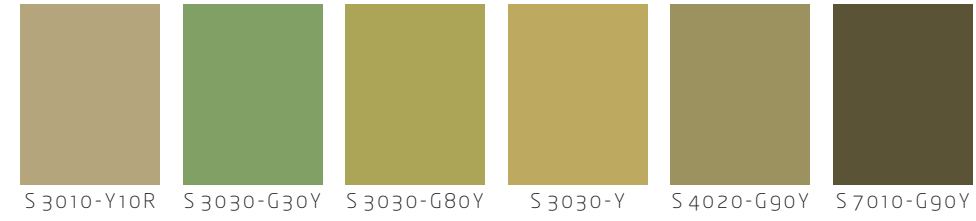
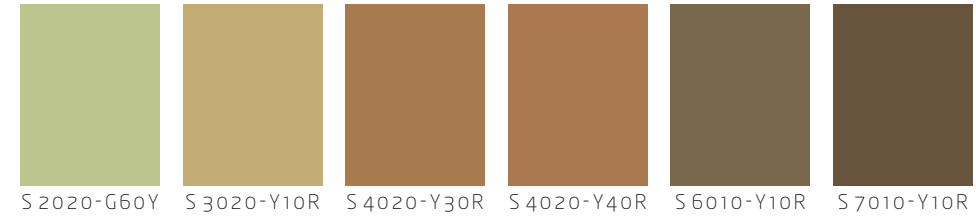





# Forest Smallholdings and Dwellings (Wellington Heath village)

p31



Forest Smallholdings and Dwellings (Wellington Heath village)

p30



Developed palette

The developed palette on page 30 reflects the intimate relationship between the village and its immediate surroundings. Set within a steep valley, views are generally internal and short ranged, framed and closed with hedges, small pasture lands and trees. Where longer views exist they are often spectacular, sometimes encompassing the textures and patterns of intensive commercial orchards or key features such as the contours of the British Camp.

The palette contains the colours of vegetation and tree bark, especially the ubiquitous birch, seen in close quarters throughout the settlement. It also contains the earthy ochre of local stone and the soft oranges of traditional brick. Many of the colours in the palette are suitable for timber cladding or timber framing, a construction detail common to several dwellings in the village. The lighter colours in soft tones respond to the play of light and shade, whilst the darker tones provide a sense of enclosure and solidity.



# Developed palette

## How to read this palette

Identify the relevant material within the groups on the left-hand side of the palette. These groups contain horizontal rows of eight colours each. It is from one of these that you will select your colour scheme.

Select one colour from the first set of three columns (labelled INTEGRATION A, B, C) within your chosen group. These colours are used to integrate prominent elevations into the landscape. Use for main walls.

Integration colours can also be used for roofing if this is a prominent feature of your design.

Read across to the right on the same row. The next two colours are a neutral grey and a tinted (coloured) grey. Choose a grey to create a transition in your building frontage, e.g. between an original building and a contemporary extension, if this is needed. The neutral grey has a close tonal relationship with the selected integration colour. If you cannot find your preferred building material in the precise integration colour you have selected then use the tonality of the neutral grey to help choose another colour of the same tone.

Select one colour from the second set of three columns. These are accent colours, used for details such as windows and doors etc. They are paired with the integration colours A-A, B-B, C-C. These pairings are recommended, however another accent colour from within the the building material group may be preferred. These colours tend to be either lighter or more intense than the integration colours, and should be used sparingly.

	INTEGRATION			NEUTRAL	TINT	CONTRAST ACCENT		
RENDER, MASONRY PAINT	A S 1505-Y10R	B S 2005-Y80R	C S 2002-Y	S 1500-N	S 1502-Y	A S 2010-Y10R	B S 2005-Y20R	C S 3010-Y
	S 2020-Y20R	S 2005-Y40R	S 3005-G80Y	S 2500-N	S 2502-Y	S 3005-G80Y	S 3005-Y50R	S 3005-Y20R
	S 4010-G90Y	S 4005-R80B	S 4005-Y20R	S 4000-N	S 3502-Y	S 3020-Y10R	S 3010-G80Y	S 3005-B20G
BRICK, STONE	S 4010-Y10R	S 4020-Y20R	S 5010-G90Y	S 4500-N	S 4502-G	S 2010-B10G	S 4005-Y20R	S 3030-Y
	S 4020-Y40R	S 4030-Y40R	S 5020-Y50R	S 4500-N	S 4502-Y	S 4005-Y50R	S 3010-B50G	S 4005-G50Y
TIMBER, FIBRE CEMENT	S 4030-Y10R	S 5020-Y30R	S 5030-G90Y	S 5000-N	S 4502-Y	S 4010-Y10R	S 4005-B20G	S 5005-R80B
	S 6010-Y30R	S 6005-Y50R	S 7005-R80B	S 6000-N	S 5502-R	S 4010-G70Y	S 5005-G80Y	S 5005-Y80R
	S 6005-G80Y	S 7010-G90Y	S 7010-G30Y	S 7000-N	S 6502-G	S 5005-R50B	S 5010-Y10R	S 5010-G50Y
METAL SHEET	S 7005-G50Y	S 8005-G50Y	S 8010-Y10R	S 8000-N	S 7502-G	S 6005-Y50R	S 6005-G50Y	S 6502-R



# Forest Smallholdings and Dwellings (Wellington Heath village) Existing palette



- colours appearing repeatedly in this Landscape Character Type

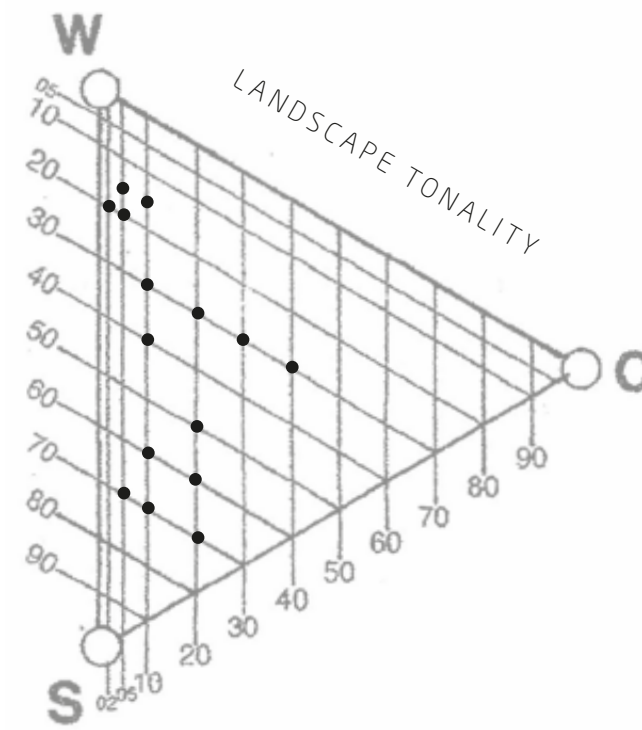

These triangular diagrams indicate the dominant tonalities recorded in this Landscape Character Area.

If you are unable to find a product which matches the colours set out in the developed palette, these diagrams indicate the acceptable range of tones which may be available in alternative colours.

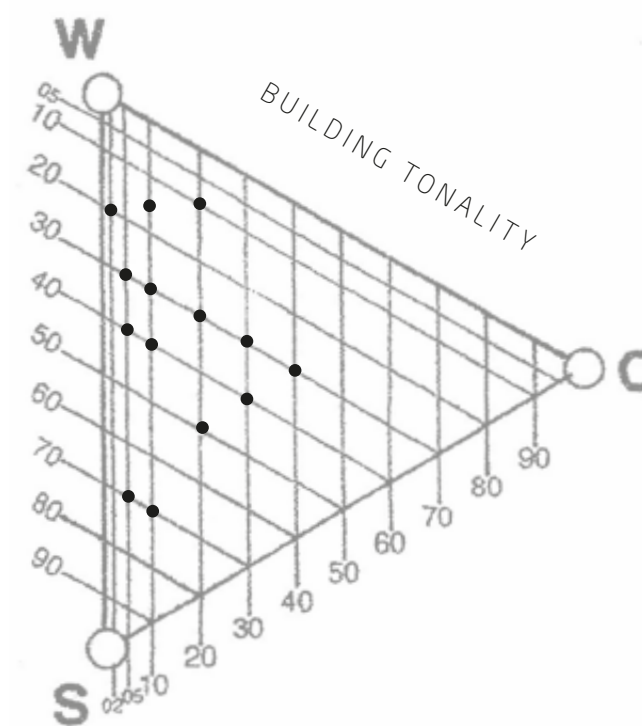
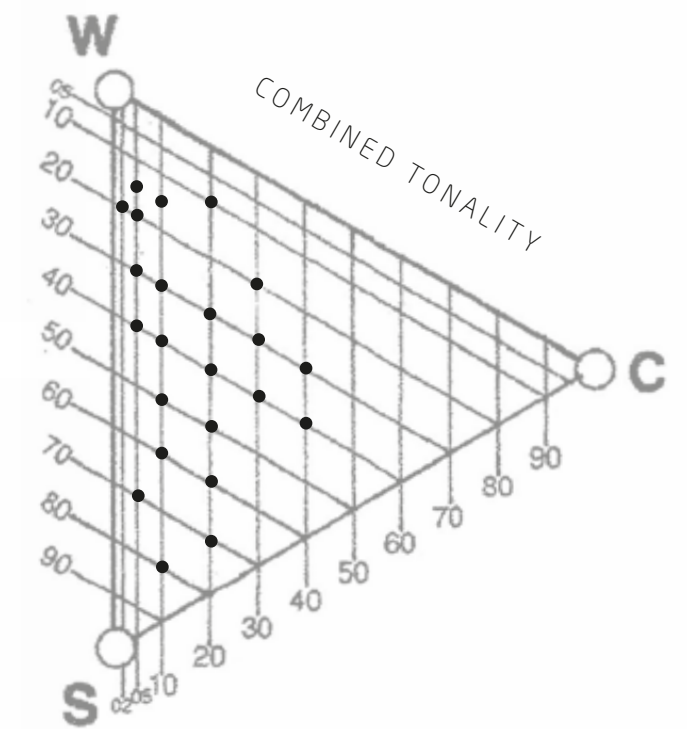



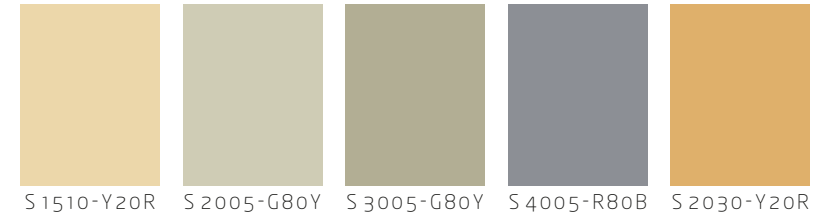
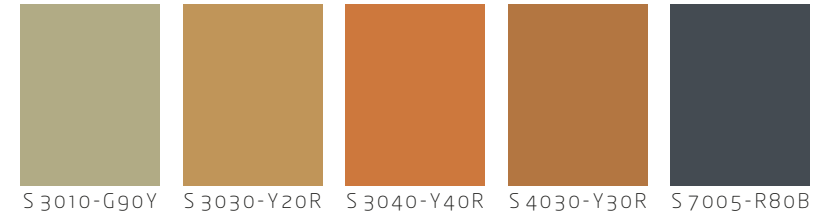
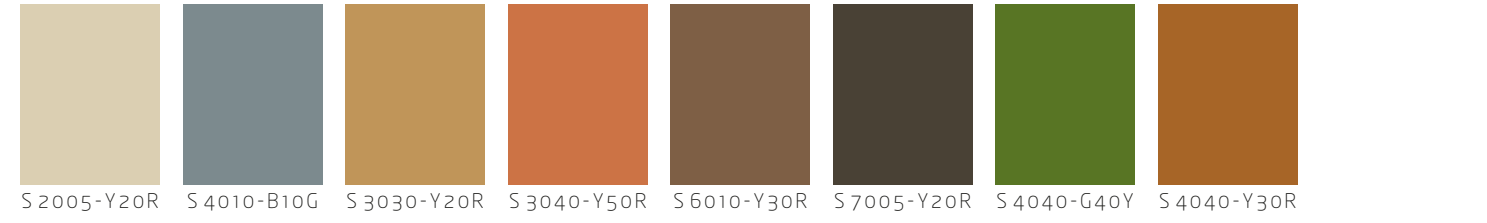
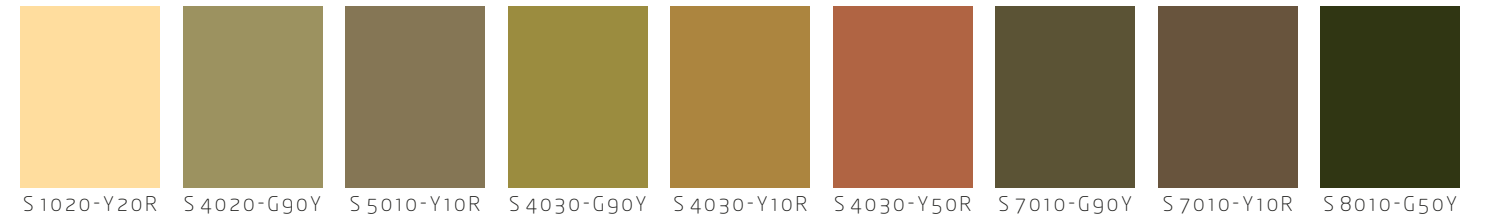



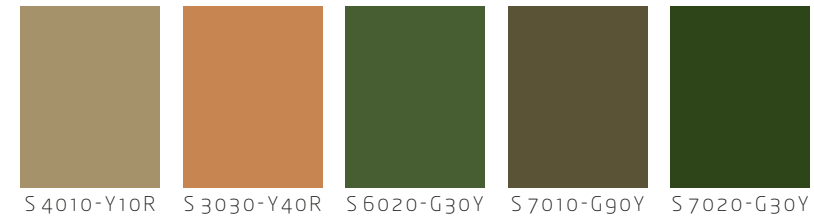
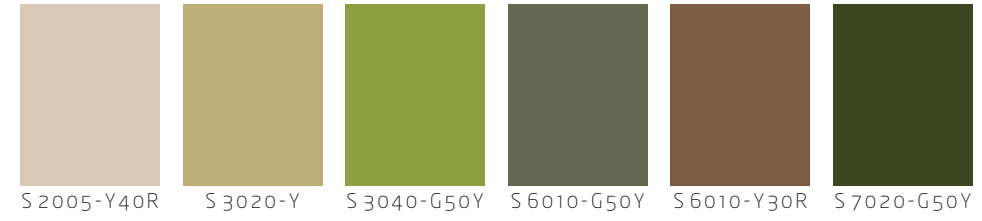
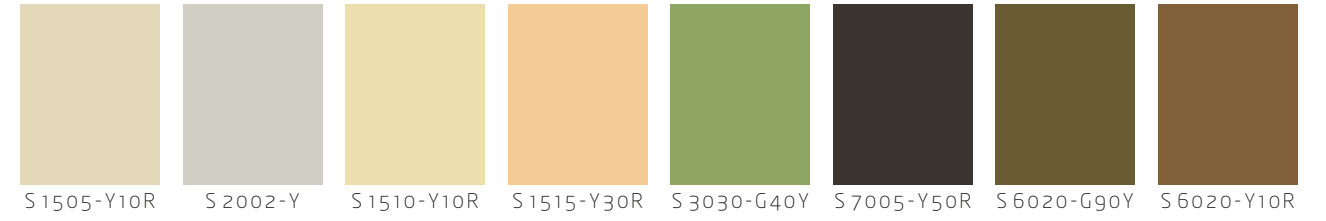
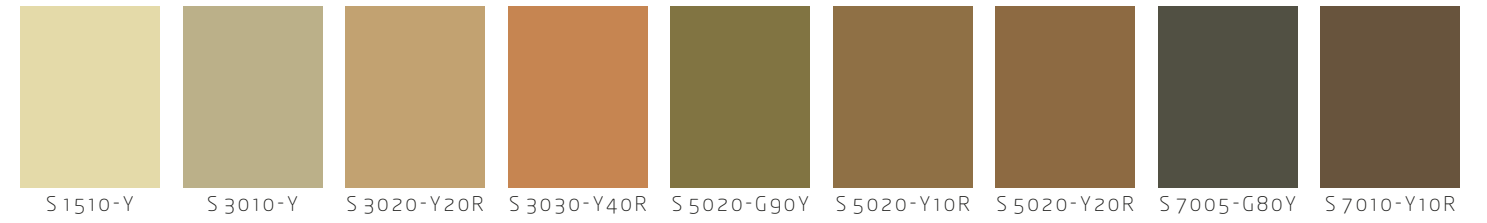





# Settled Farmlands with Pastoral Land Use

p36



Settled Farmlands with Pastoral Land Use

p35



Developed palette

The developed palette on page 35 is derived from the largely pastoral nature of this Landscape Character Type. The greens vary from orchards and unimproved rough grazing through to fields bounded by mature hedgerows with occasional trees. Some darkened versions of these hues are found in the integration colours but many more, in softer tones, contribute to the range of accent colours. Balance to the palette is provided by the rich colours and tones of traditional orange red bricks and timber framed buildings.



# Developed palette

## How to read this palette

Identify the relevant material within the groups on the left-hand side of the palette. These groups contain horizontal rows of eight colours each. It is from one of these that you will select your colour scheme.

Select one colour from the first set of three columns (labelled INTEGRATION A, B, C) within your chosen group. These colours are used to integrate prominent elevations into the landscape. Use for main walls.

Integration colours can also be used for roofing if this is a prominent feature of your design.

Read across to the right on the same row. The next two colours are a neutral grey and a tinted (coloured) grey. Choose a grey to create a transition in your building frontage, e.g. between an original building and a contemporary extension, if this is needed. The neutral grey has a close tonal relationship with the selected integration colour. If you cannot find your preferred building material in the precise integration colour you have selected then use the tonality of the neutral grey to help choose another colour of the same tone.

Select one colour from the second set of three columns. These are accent colours, used for details such as windows and doors etc. They are paired with the integration colours A-A, B-B, C-C. These pairings are recommended, however another accent colour from within the the building material group may be preferred. These colours tend to be either lighter or more intense than the integration colours, and should be used sparingly.

	INTEGRATION			NEUTRAL	TINT	CONTRAST ACCENT		
RENDER, MASONRY PAINT	A S 3005-G80Y	B S 4005-Y20R	C S 4010-Y30R	S 3500-N	S 3502-Y	A S 1005-G80Y	B S 1005-Y20R	C S 1005-Y30R
	S 5010-Y70R	S 3005-Y50R	S 3020-Y50R	S 3500-N	S 3502-Y	S 3010-G70Y	S 3010-B50G	S 3020-G50Y
	S 4010-G50Y	S 4020-Y50R	S 5010-G70Y	S 4000-N	S 4502-Y	S 2010-G50Y	S 3005-R50B	S 3010-Y70R
BRICK, STONE	S 5010-Y10R	S 3030-Y50R	S 4020-Y60R	S 4000-N	S 4502-Y	S 2010-Y10R	S 3005-G50Y	S 2005-Y60R
	S 5010-G50Y	S 5020-Y60R	S 6010-Y30R	S 5000-N	S 5502-Y	S 2010-B50G	S 2010-G60Y	S 1010-Y30R
TIMBER, FIBRE CEMENT	S 6005-Y50R	S 6010-Y90R	S 6502-R	S 6000-N	S 6502-Y	S 3005-Y50R	S 2010-G90Y	S 3502-G
	S 7005-Y20R	S 6010-G50Y	S 6020-Y90R	S 6500-N	S 6502-Y	S 3005-Y20R	S 4010-G50Y	S 3005-B80G
METAL SHEET	S 7010-G50Y	S 7010-Y10R	S 8010-Y30R	S 7000-N	S 7502-Y	S 3010-G50Y	S 3010-Y10R	S 4020-Y
	S 8005-Y20R	S 8005-G80Y	S 8005-Y50R	S 8000-N	S 8502-Y	S 4005-Y20R	S 4005-G80Y	S 4005-Y50R



# Settled Farmlands with Pastoral Land Use Existing palette



- colours appearing repeatedly in this Landscape Character Type

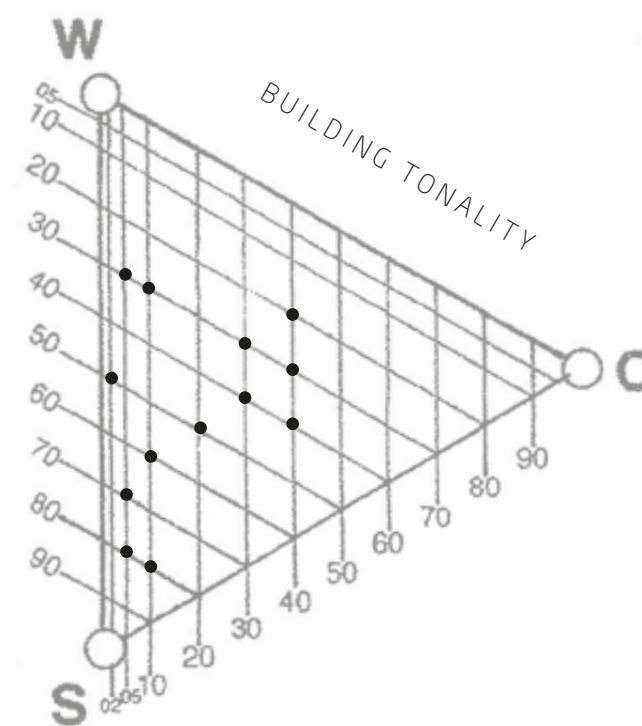
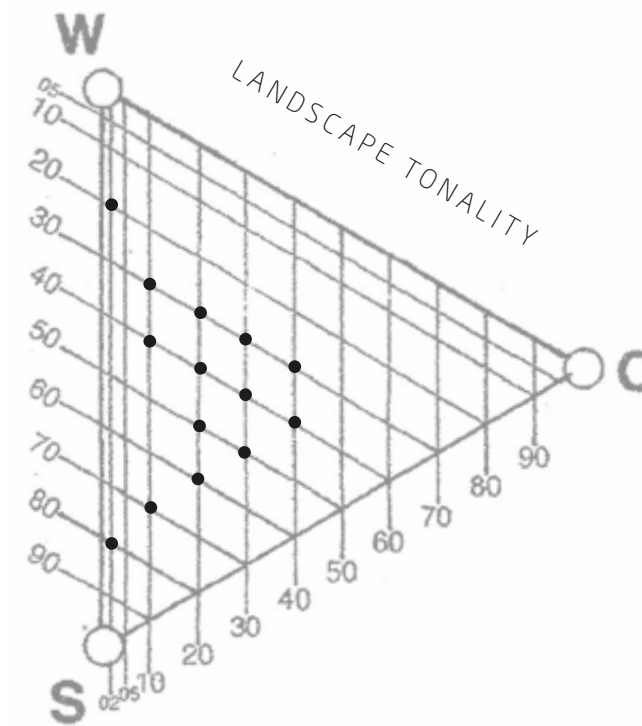

These triangular diagrams indicate the dominant tonalities recorded in this Landscape Character Area.

If you are unable to find a product which matches the colours set out in the developed palette, these diagrams indicate the acceptable range of tones which may be available in alternative colours.

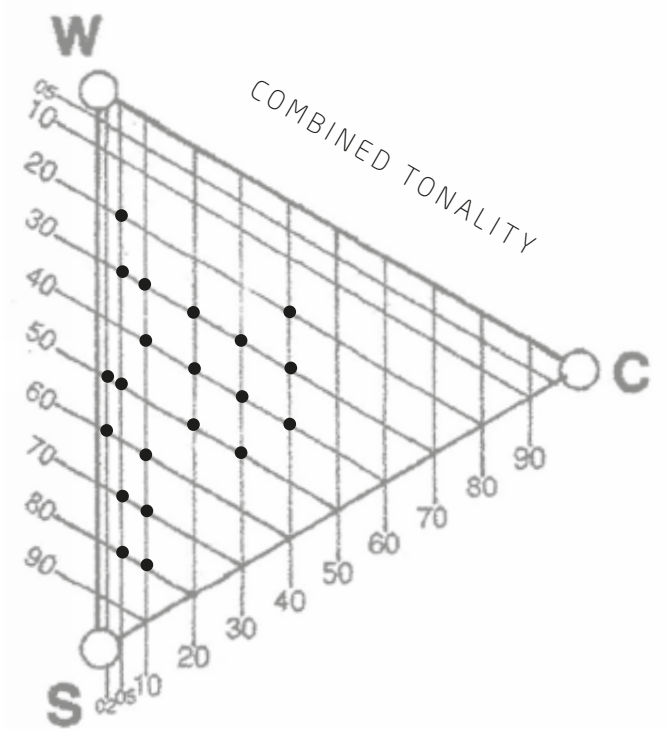



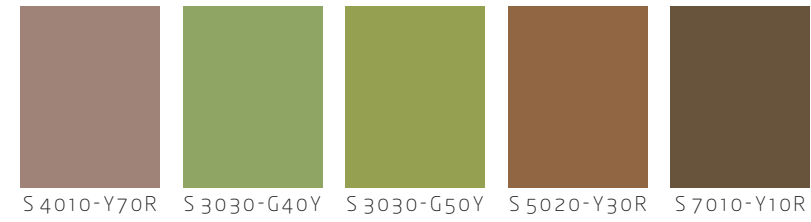
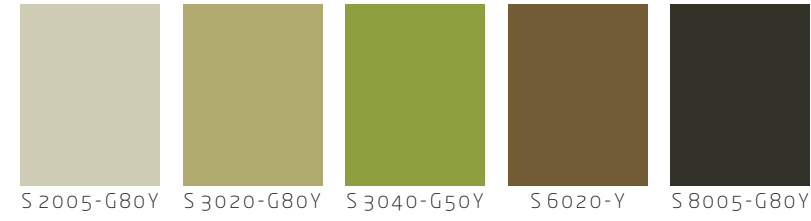
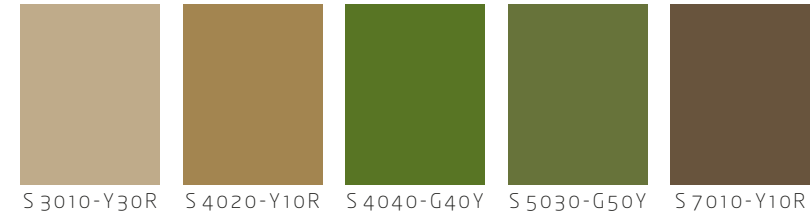
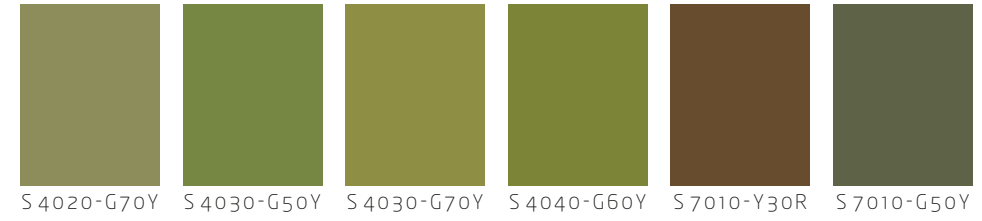



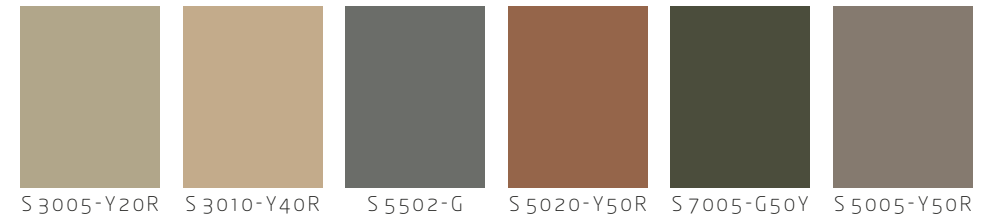
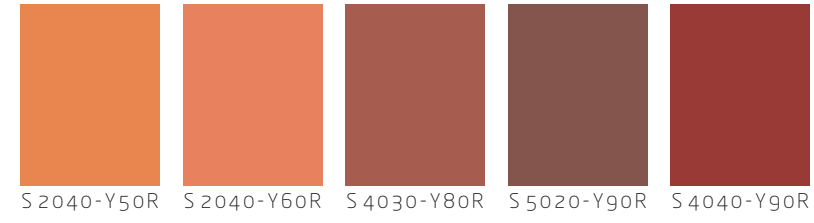
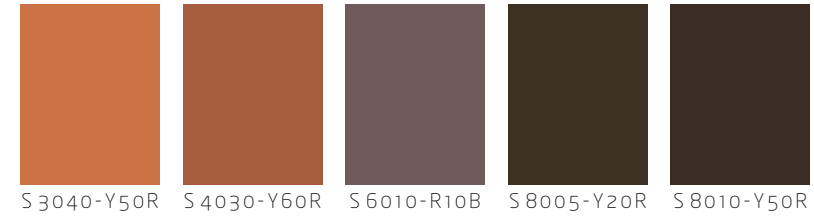
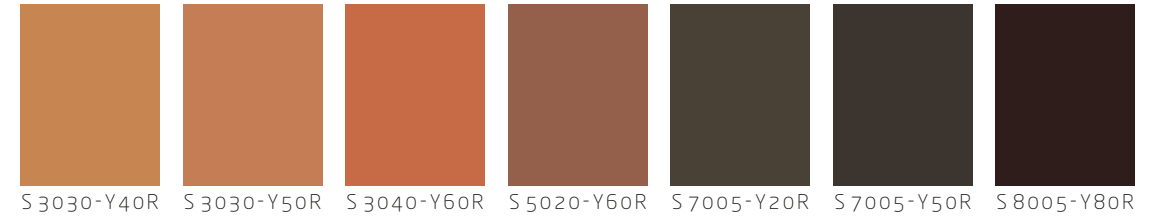



# Settled Farmlands on River Terraces and Sandstone Estatelands

p41

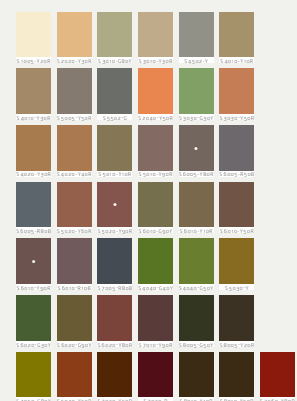

Settled Farmlands on River Terraces

p44

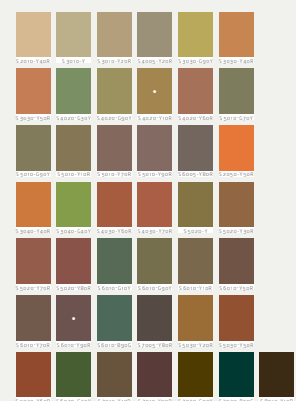

Sandstone Estatelands

p40



Developed palette

The developed palette on page 40 reflects the dominant land use of these Landscape Character Types. Fertile sandy soils are readily seen beneath commercial orchards and in arable cropping lands. The winter hues of fruit trees combined with the red brown soil colours underpin the colour range. Underlying red sandstone enriches the palette with deep and dense colours, reinforced by dark timber framed buildings, masonry and traditional brick.



# Developed palette

## How to read this palette

Identify the relevant material within the groups on the left-hand side of the palette. These groups contain horizontal rows of eight colours each. It is from one of these that you will select your colour scheme.

Select one colour from the first set of three columns (labelled INTEGRATION A, B, C) within your chosen group. These colours are used to integrate prominent elevations into the landscape. Use for main walls.

Integration colours can also be used for roofing if this is a prominent feature of your design.

Read across to the right on the same row. The next two colours are a neutral grey and a tinted (coloured) grey. Choose a grey to create a transition in your building frontage, e.g. between an original building and a contemporary extension, if this is needed. The neutral grey has a close tonal relationship with the selected integration colour. If you cannot find your preferred building material in the precise integration colour you have selected then use the tonality of the neutral grey to help choose another colour of the same tone.

Select one colour from the second set of three columns. These are accent colours, used for details such as windows and doors etc. They are paired with the integration colours A-A, B-B, C-C. These pairings are recommended, however another accent colour from within the the building material group may be preferred. These colours tend to be either lighter or more intense than the integration colours, and should be used sparingly.

	INTEGRATION			NEUTRAL	TINT	CONTRAST ACCENT		
RENDER, MASONRY PAINT	A	B	C			A	B	C
	S 2020-Y30R	S 3010-Y20R	S 4005-Y20R	S 3000-N	S 2502-Y	S 0520-Y30R	S 1010-Y20R	S 2005-Y30R
BRICK, STONE								
	S 6010-Y90R	S 6005-Y80R	S 3040-Y50R	S 5000-N	S 4502-Y	S 4010-G90Y	S 4005-G80Y	S 3010-B50G
TIMBER, FIBRE CEMENT								
	S 6010-R10B	S 6010-Y50R	S 6020-Y	S 6000-N	S 5502-Y	S 4010-Y10R	S 4020-Y50R	S 4020-Y
METAL SHEET, TILES								
	S 7010-Y90R	S 6020-Y60R	S 8010-Y50R	S 7000-N	S 7502-Y	S 5010-G90Y	S 5005-Y50R	S 5005-G50Y



# Settled Farmlands on River Terraces

## Existing palette



- colours appearing repeatedly in this Landscape Character Type

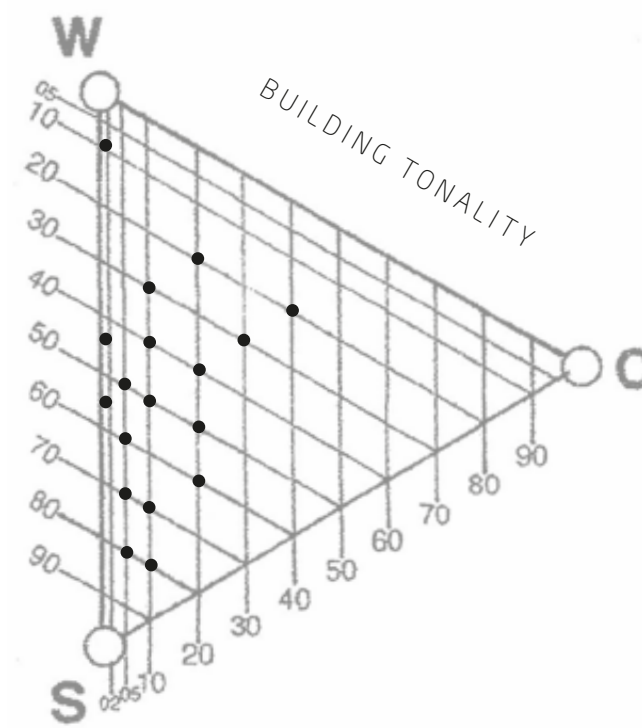
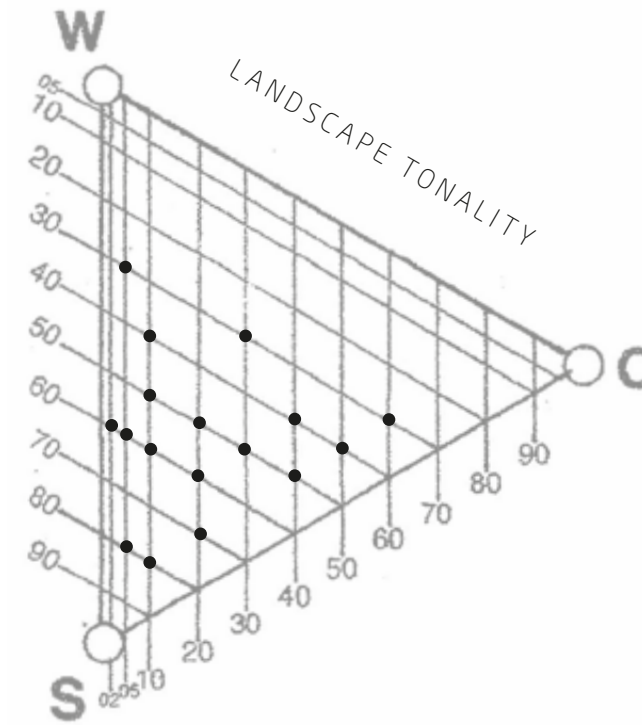

These triangular diagrams indicate the dominant tonalities recorded in this Landscape Character Area.

If you are unable to find a product which matches the colours set out in the developed palette, these diagrams indicate the acceptable range of tones which may be available in alternative colours.

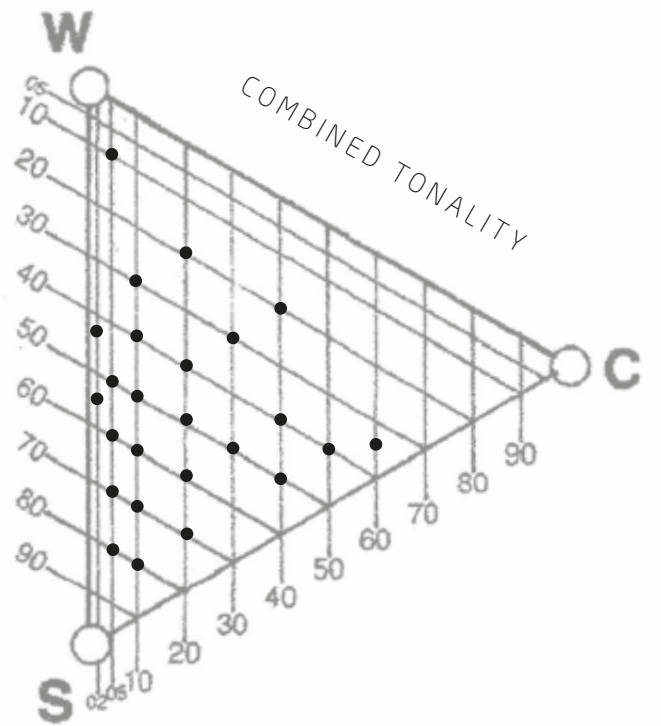



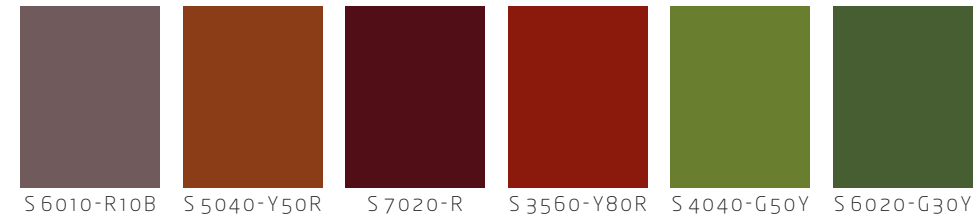
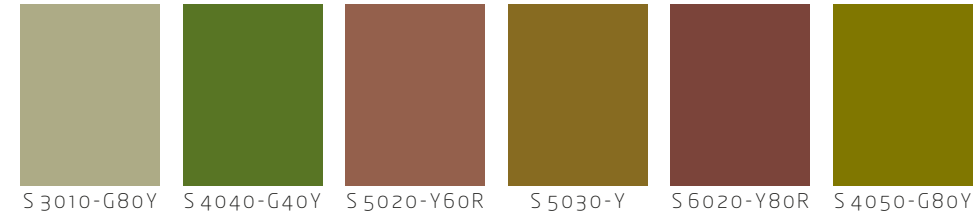
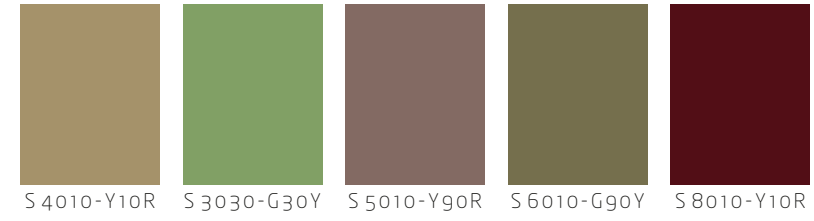
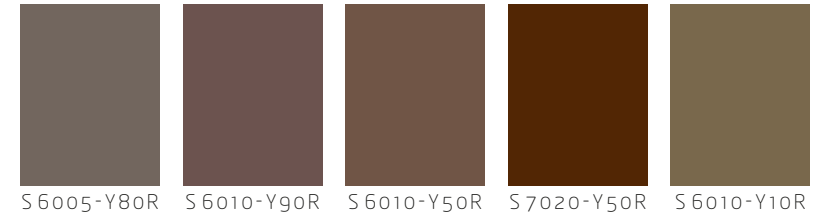



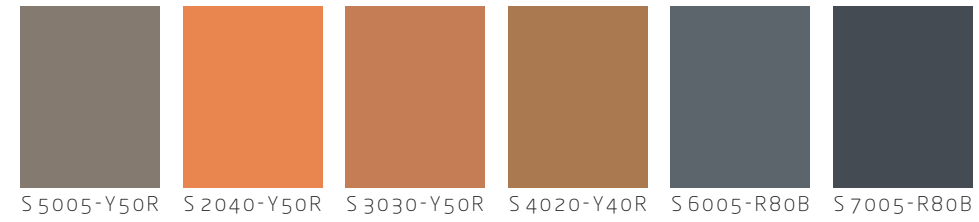
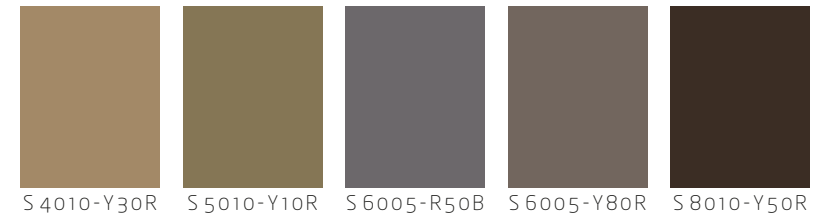
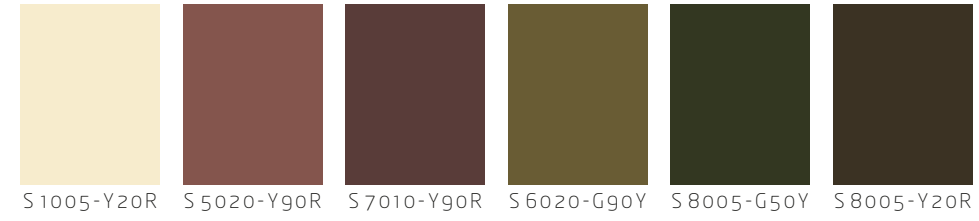
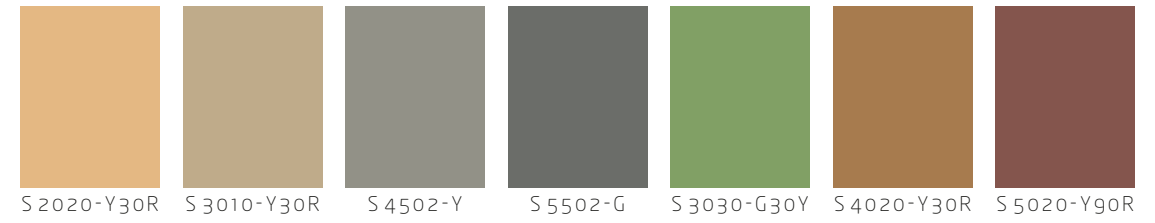



# Sandstone Estatelands Existing palette

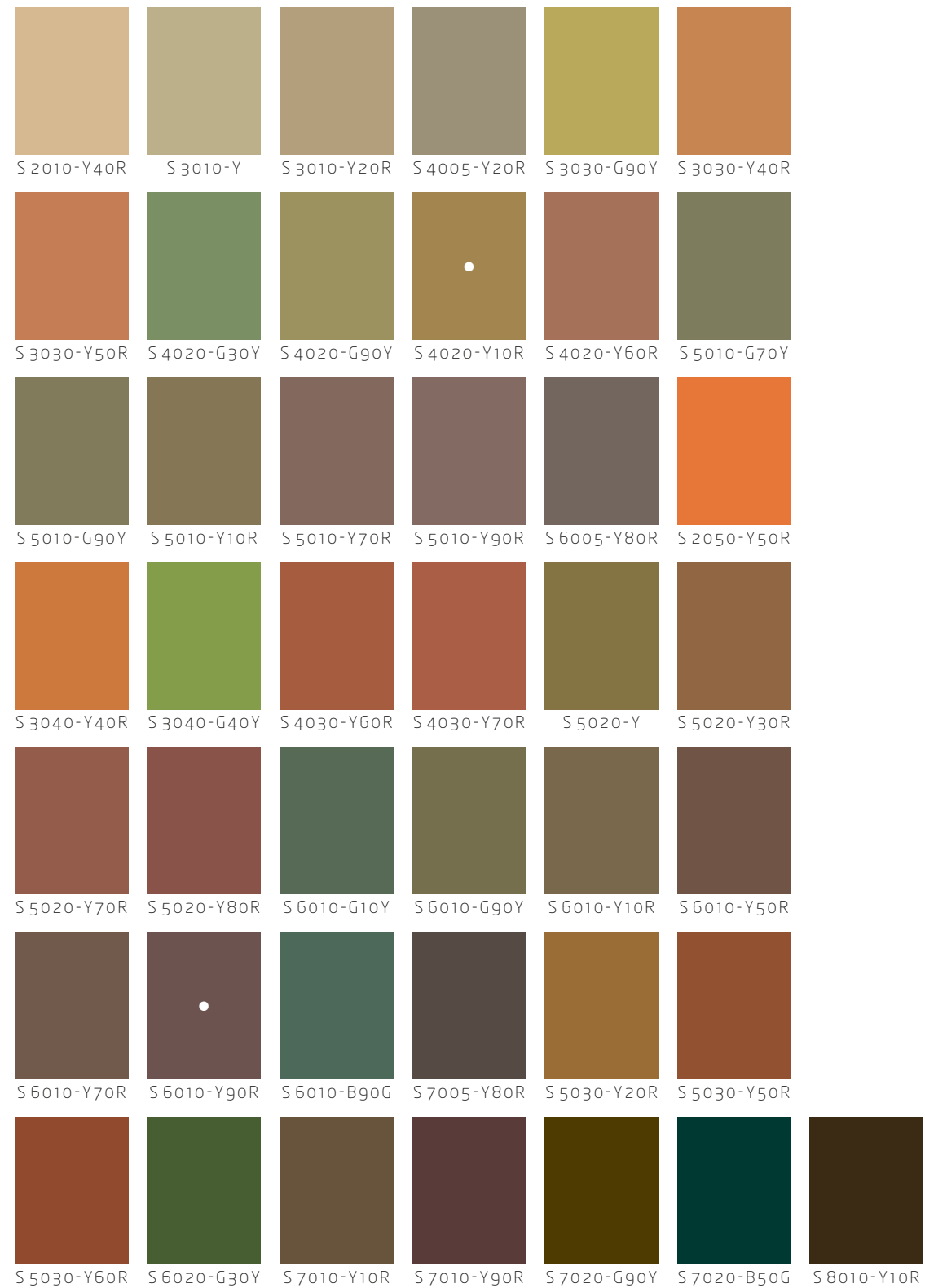

- colours appearing repeatedly in this Landscape Character Type

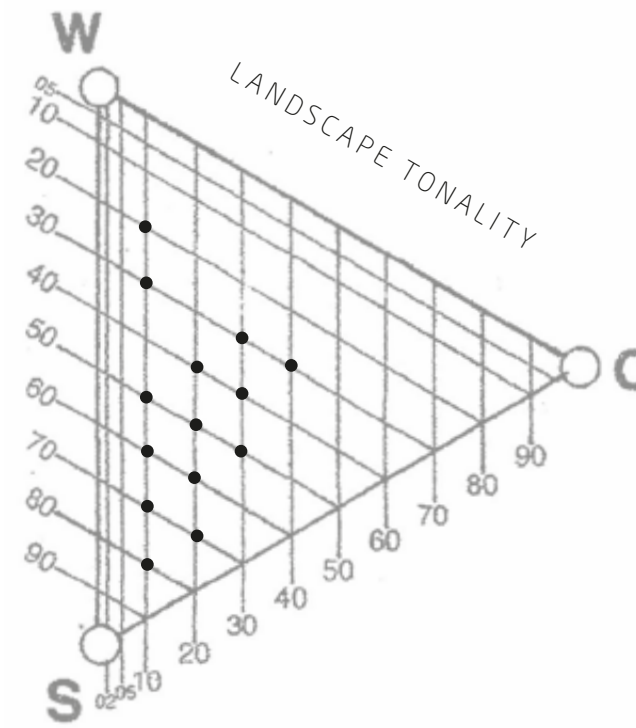

These triangular diagrams indicate the dominant tonalities recorded in this Landscape Character Area.

If you are unable to find a product which matches the colours set out in the developed palette, these diagrams indicate the acceptable range of tones which may be available in alternative colours.

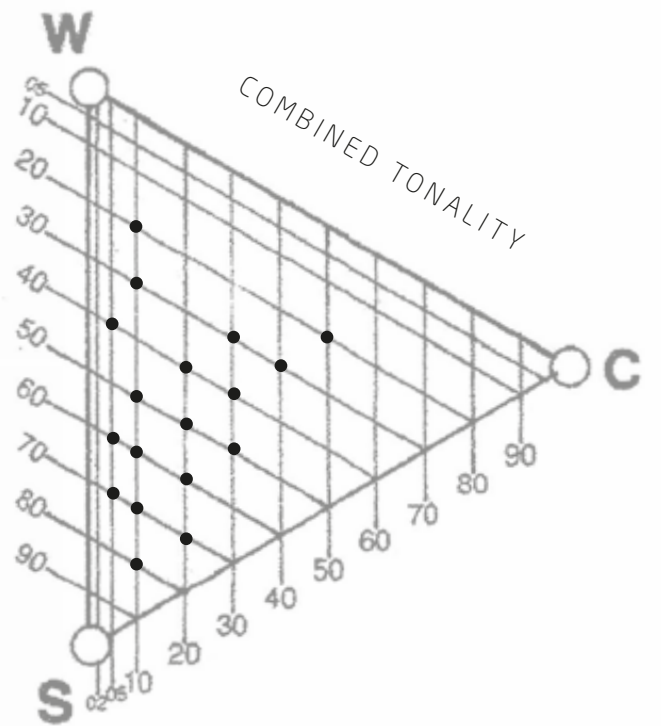
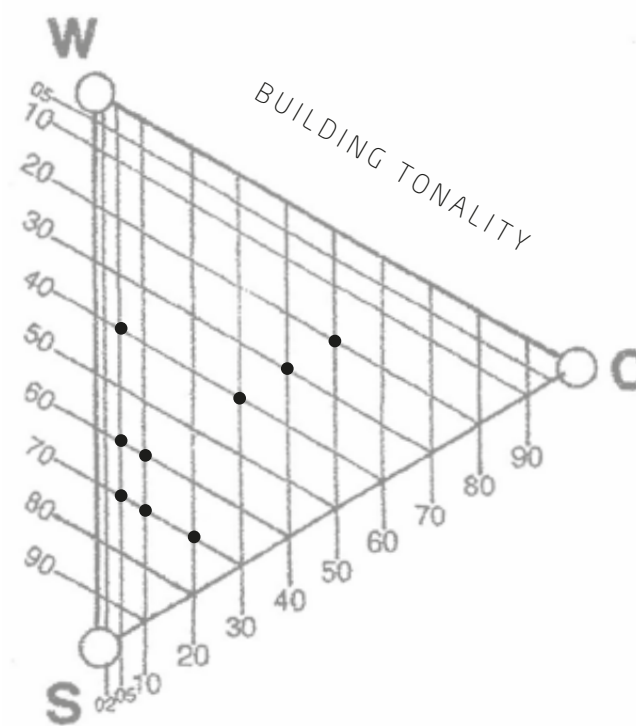



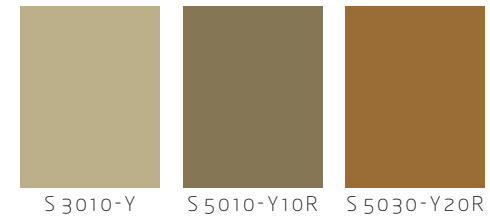
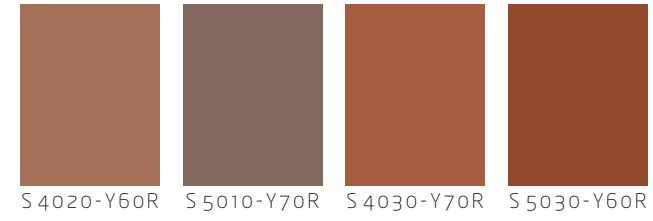
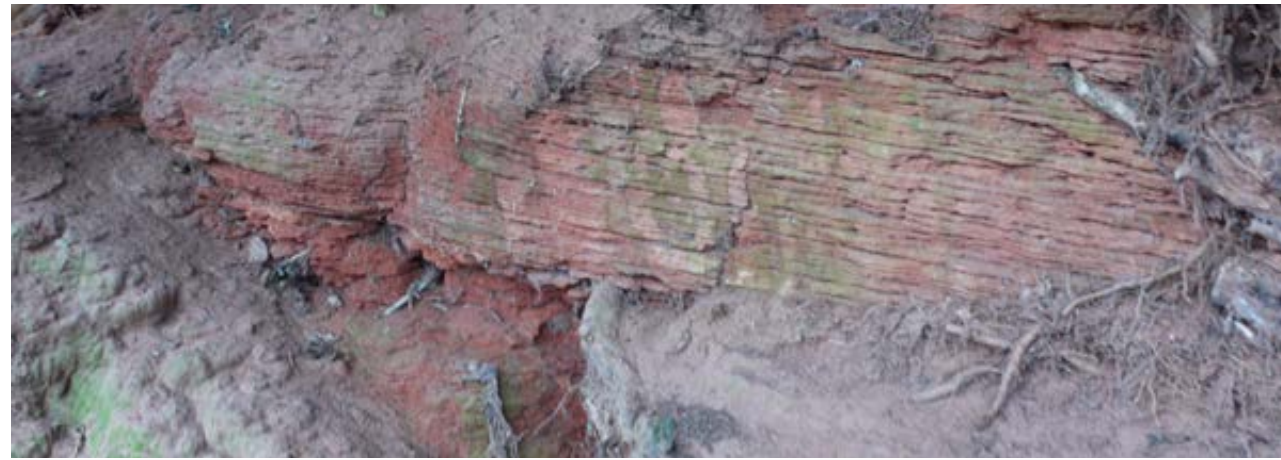
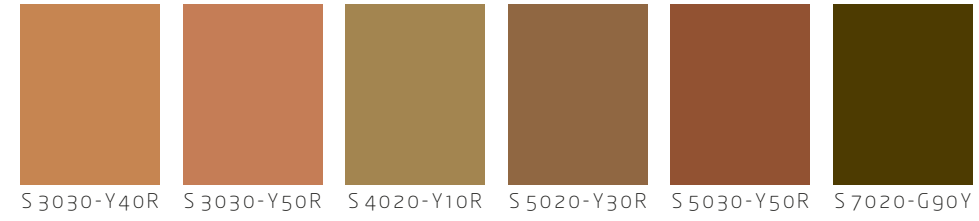
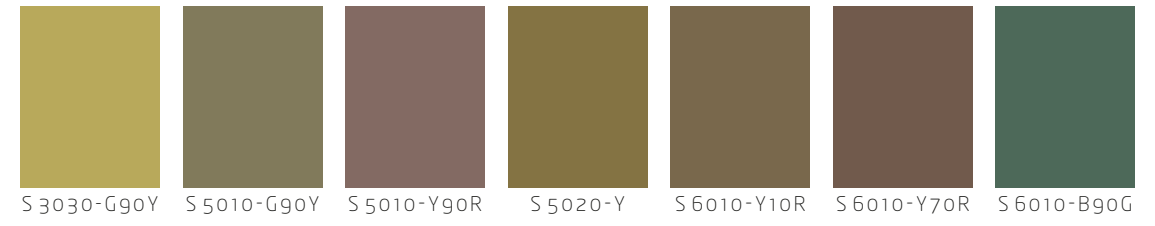



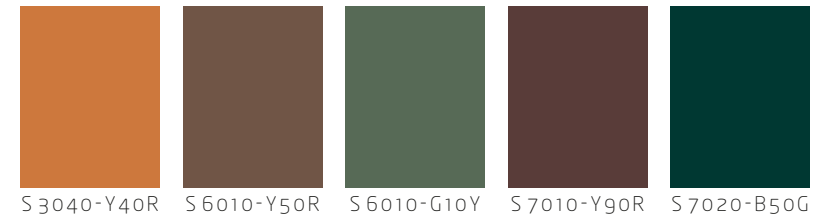
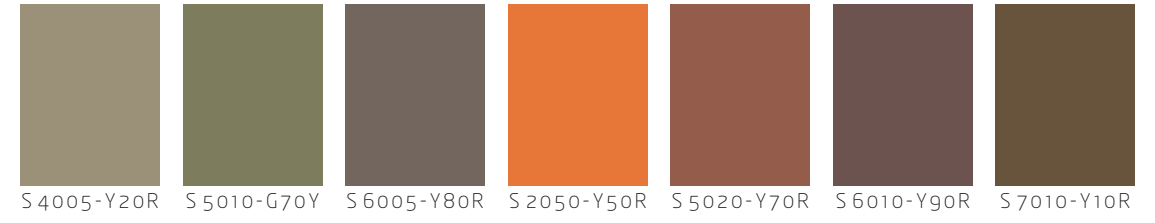
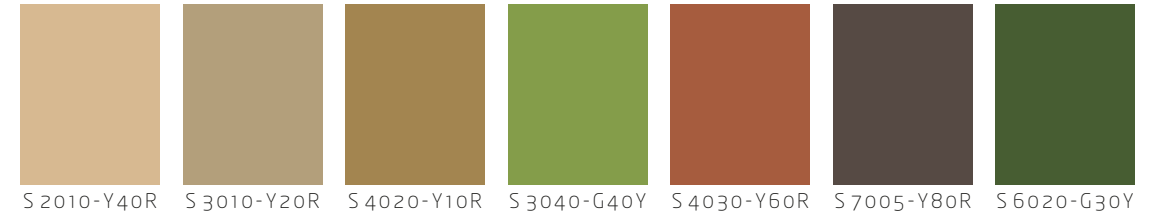
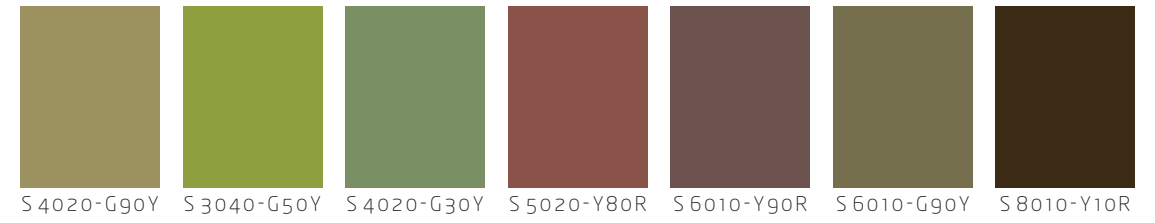





# Enclosed Commons

p49



Enclosed Commons

p48



Developed palette

This developed palette on page 48 follows the pastoral land use which is characteristic across much of the Unenclosed Commons Landscape Character Type, with a range of grey yellow / greens reflecting the varied nature of the sward. Darker tones pick up the well defined hedgerows, and arable land where this occurs.

The palette incorporates a range of off-whites and creams, derived from the landscape but significantly lightened, for render and paint application and also a range of masonry and brick colours reflecting the traditional dwellings in the area. Accent colours provide opportunities to animate and articulate wayside dwelling extensions and new builds with colours drawn from all sectors of the colour wheel. The darkest colours are reserved for agricultural buildings and other associated uses.



# Developed palette

## How to read this palette

Identify the relevant material within the groups on the left-hand side of the palette. These groups contain horizontal rows of eight colours each. It is from one of these that you will select your colour scheme.

Select one colour from the first set of three columns (labelled INTEGRATION A, B, C) within your chosen group. These colours are used to integrate prominent elevations into the landscape. Use for main walls. Integration colours can also be used for roofing if this is a prominent feature of your design.

Read across to the right on the same row. The next two colours are a neutral grey and a tinted (coloured) grey. Choose a grey to create a transition in your building frontage, e.g. between an original building and a contemporary extension, if this is needed. The neutral grey has a close tonal relationship with the selected integration colour. If you cannot find your preferred building material in the precise integration colour you have selected then use the tonality of the neutral grey to help choose another colour of the same tone.

Select one colour from the second set of three columns. These are accent colours, used for details such as windows and doors etc. They are paired with the integration colours A-A, B-B, C-C. These pairings are recommended, however another accent colour from within the the building material group may be preferred. These colours tend to be either lighter or more intense than the integration colours, and should be used sparingly.

	INTEGRATION			NEUTRAL	TINT	CONTRAST ACCENT		
RENDER, MASONRY PAINT	A	B	C			A	B	C
	S 0505-G80Y	S 0502-Y	S 1005-G80Y	S 0500-N		S 2005-G80Y	S 2502-Y	S 3005-G80Y
	S 0603-G40Y	S 0505-G90Y	S 1010-G90Y	S 1000-N		S 2005-G40Y	S 2005-G90Y	S 3010-G90Y
	S 3502-Y	S 3010-G40Y	S 4010-G90Y	S 3500-N	S 4502-Y	S 4020-Y	S 3010-R40B	S 3010-R90B
S 4010-Y10R	S 3020-G90Y	S 4020-G50Y	S 4000-N	S 4502-Y	S 2010-B10G	S 2005-R90B	S 2005-R50B	
BRICK, STONE, TIMBER								
	S 4020-Y30R	S 4010-G70Y	S 6010-Y30R	S 4500-N	S 5502-Y	S 2020-Y30R	S 2010-R70B	S 2010-G30Y
	S 6010-Y90R	S 5020-G50Y	S 5020-Y30R	S 5000-N	S 5502-Y	S 3010-Y90R	S 2020-G50Y	S 3020-Y30R
	S 5020-Y50R	S 6010-Y10R	S 4030-Y60R	S 6000-N	S 5502-R	S 5005-Y50R	S 2010-Y10R	S 3010-G60Y
STEEL SHEET								
	S 7010-Y10R	S 5010-G50Y	S 7502-R	S 7000-N	S 6502-Y	S 3010-Y10R	S 1010-G50Y	S 2502-R
	S 7010-G50Y	S 8010-Y90R	S 8010-G90Y	S 8000-N	S 7502-Y	S 2010-G50Y	S 4010-Y90R	S 3010-G90Y



# Enclosed Commons Existing palette

S2005-G80Y	S2502-Y	S1515-G80Y	S2010-G40Y	S2020-G90Y	S3010-G90Y
S3010-Y	S3010-G50Y	S2030-G90Y	S2040-G50Y	S3030-G30Y	S3030-G50Y
S3030-Y	S3030-Y30R	S4020-G70Y	S4020-Y	S5010-Y10R	S5010-Y30R
S5010-Y90R	S6005-G80Y	S6502-Y	S3040-G40Y	S3040-G80Y	S3040-Y30R
S4030-Y30R	S4030-Y50R	S4030-Y60R	S5020-Y10R	S5020-Y50R	S6010-G50Y
S6010-Y10R	S6010-Y30R	S7005-Y20R	S7005-R50B	S4040-G50Y	S5030-G90Y
S5030-Y50R	S6020-G50Y	S6020-Y90R	S7010-Y30R	S7010-Y90R	S7020-G90Y

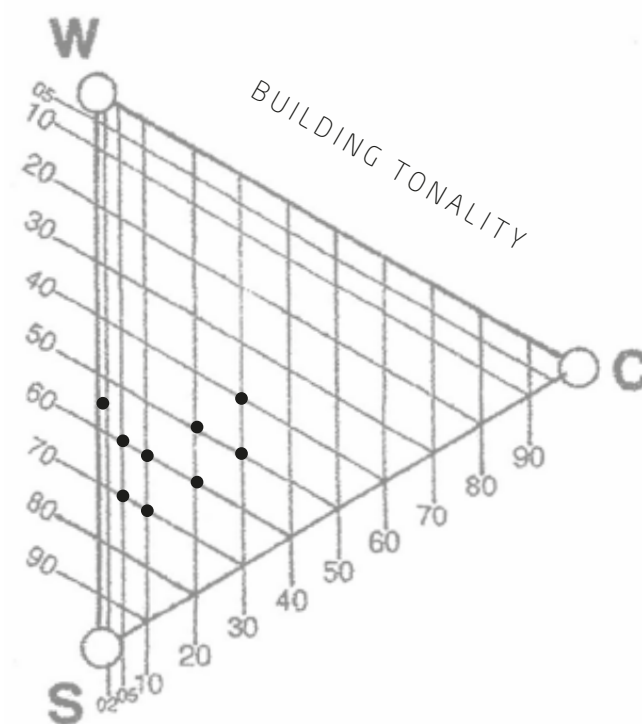
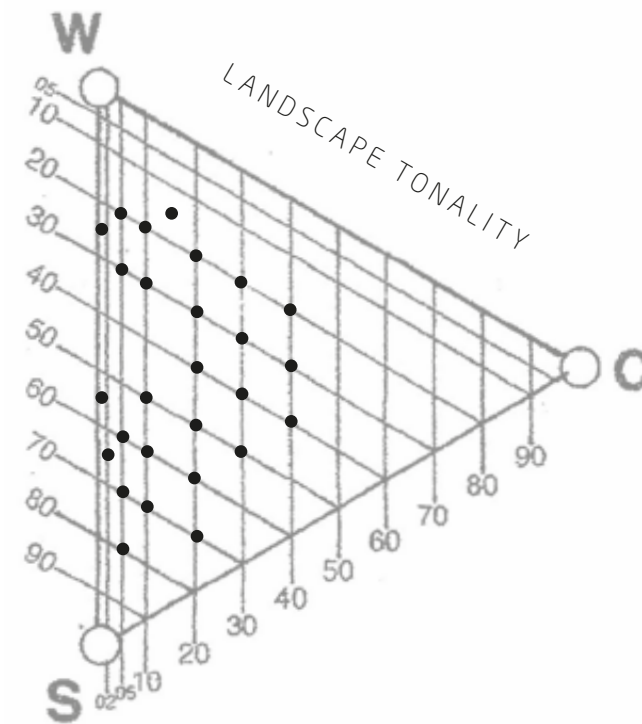

These triangular diagrams indicate the dominant tonalities recorded in this Landscape Character Area.

If you are unable to find a product which matches the colours set out in the developed palette, these diagrams indicate the acceptable range of tones which may be available in alternative colours.

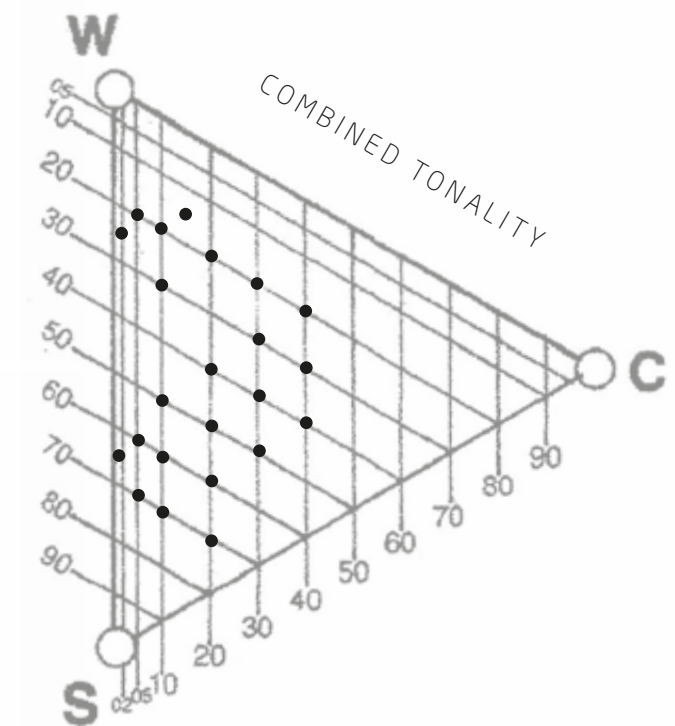



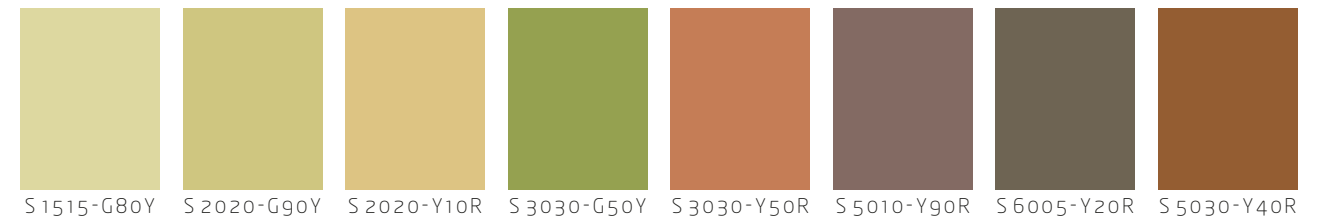
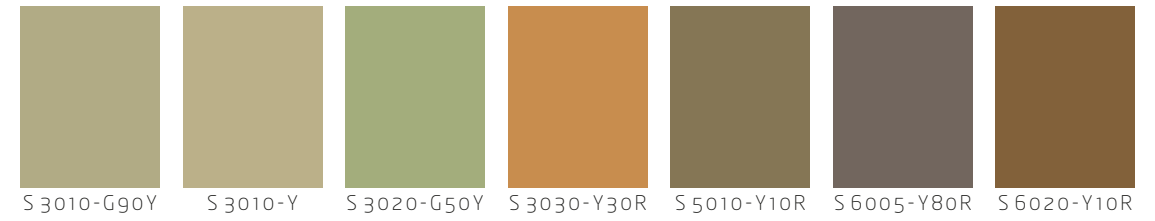
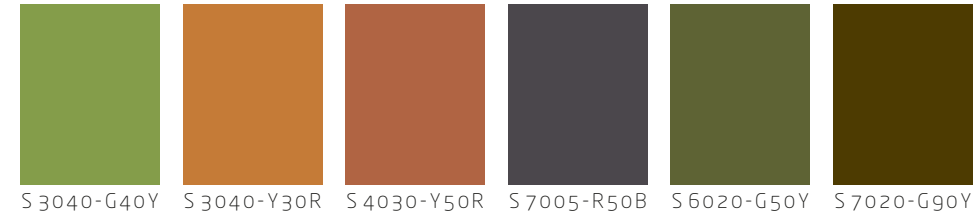
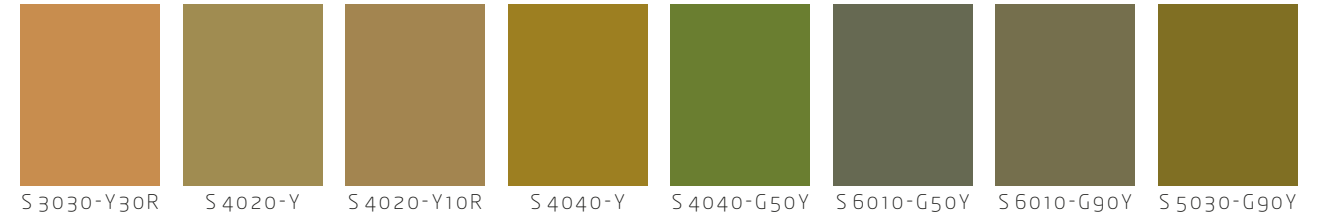



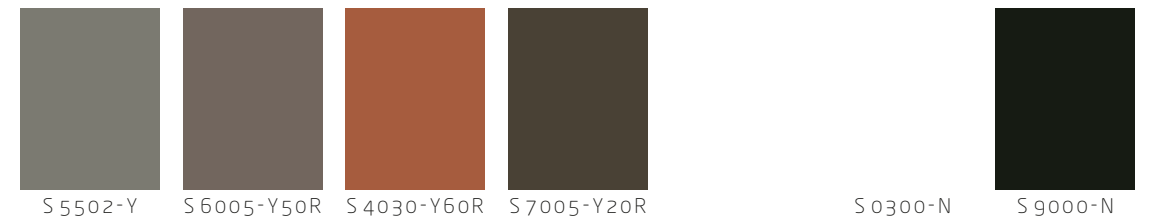
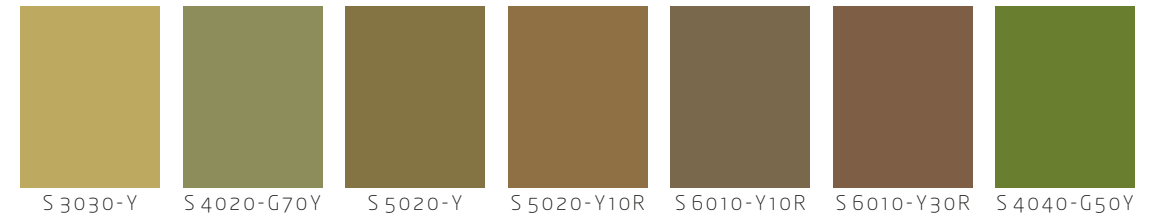
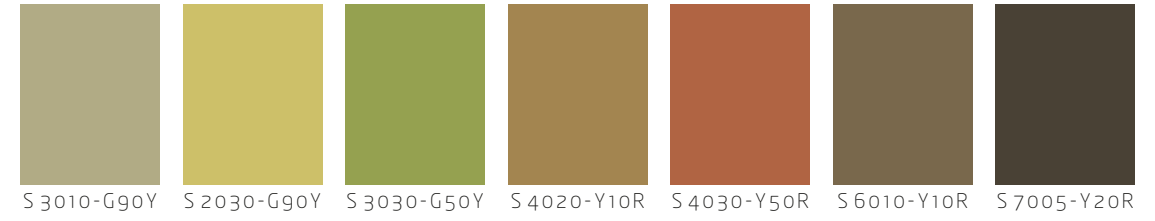
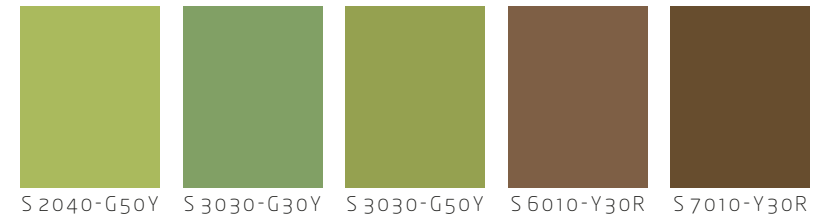



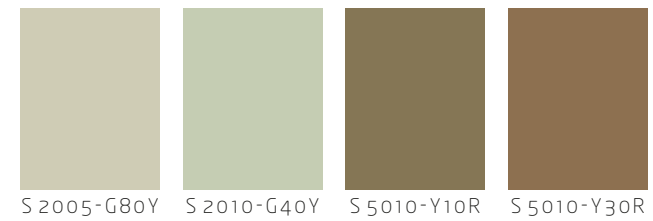
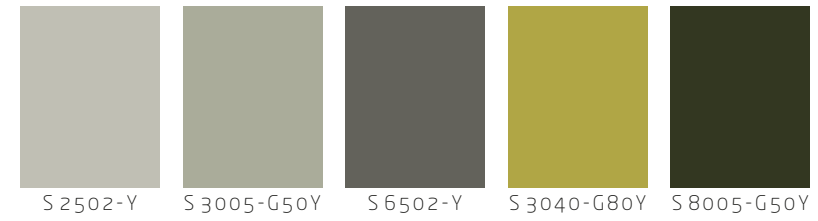
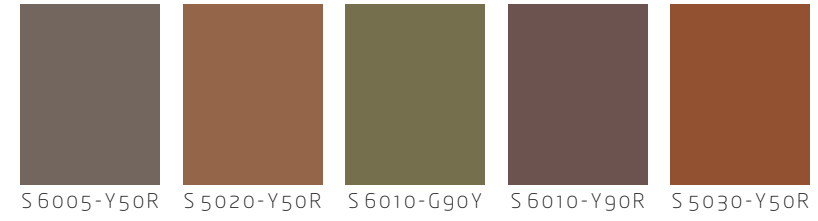
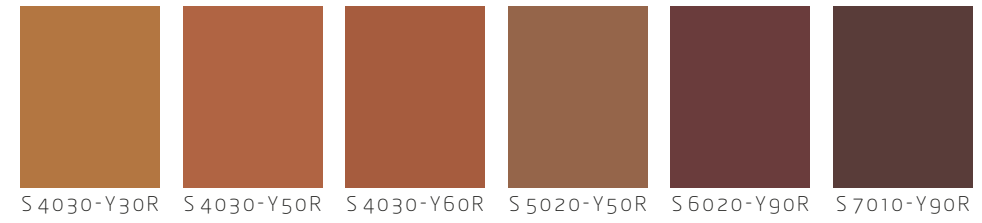





# Welland

P55



Welland

P54



Developed palette

The village of Welland is developing rapidly with new housing underway in early 2016 and more planned. The developed palette on page 54 recognises this with a focus on the colours of construction, but derived from the more traditional buildings to minimise the risks of ubiquitous urbanisation.

Brick, stone, tile and slate colours are provided with reference also made to the landscape context of unenclosed commons, small orchards and the high hills and slopes of the Malvern Hills. New housing, especially that designated for sites to the west of the Gloucester Road, would benefit from drawing upon the landscape colours present in the palette to maintain a sense of local identity.



# Developed palette

## How to read this palette

Identify the relevant material within the groups on the left-hand side of the palette. These groups contain horizontal rows of eight colours each. It is from one of these that you will select your colour scheme.

Select one colour from the first set of three columns (labelled INTEGRATION A, B, C) within your chosen group. These colours are used to integrate prominent elevations into the landscape. Use for main walls.

Integration colours can also be used for roofing if this is a prominent feature of your design.

Read across to the right on the same row. The next two colours are a neutral grey and a tinted (coloured) grey. Choose a grey to create a transition in your building frontage, e.g. between an original building and a contemporary extension, if this is needed. The neutral grey has a close tonal relationship with the selected integration colour. If you cannot find your preferred building material in the precise integration colour you have selected then use the tonality of the neutral grey to help choose another colour of the same tone.

Select one colour from the second set of three columns. These are accent colours, used for details such as windows and doors etc. They are paired with the integration colours A-A, B-B, C-C. These pairings are recommended, however another accent colour from within the the building material group may be preferred. These colours tend to be either lighter or more intense than the integration colours, and should be used sparingly.

	INTEGRATION			NEUTRAL	TINT	CONTRAST ACCENT		
RENDER, MASONRY PAINT	A	B	C			A	B	C
	S 0502-Y50R	S 0505-Y20R	S 1005-Y20R	S 0500-N	S 0502-Y	S 1502-G	S 1505-Y20R	S 2005-Y20R
BRICK, STONE, FIBRE CEMENT								
TILE, SLATE								
METAL SHEET								



# Welland Existing palette

S 0502-Y	S 0505-Y50R	S 3005-Y20R	S 4005-Y20R	S 3020-Y	S 3020-Y10R
S 3020-Y20R	S 5005-G80Y	S 5005-Y20R	S 3030-G60Y	S 3030-Y40R	S 3030-Y20R
S 4020-G50Y	S 5010-Y30R	S 5010-R90B	S 6502-B	S 3040-Y50R	S 3040-Y60R
S 4030-G70Y	S 4030-Y50R	S 5020-Y10R	S 5020-Y20R	S 5020-Y30R	S 5020-Y70R
S 6010-G90Y	S 6010-Y10R	S 6010-Y30R	S 6010-Y50R	S 7005-Y50R	S 7005-R50B
S 5030-Y	S 5030-Y50R	S 5030-Y60R	S 6020-Y50R	S 6020-Y60R	S 7010-Y10R
S 7010-Y90R	S 7020-G90Y	S 7020-G50Y	S 8010-Y50R		

- colours appearing repeatedly in this Landscape Character Type

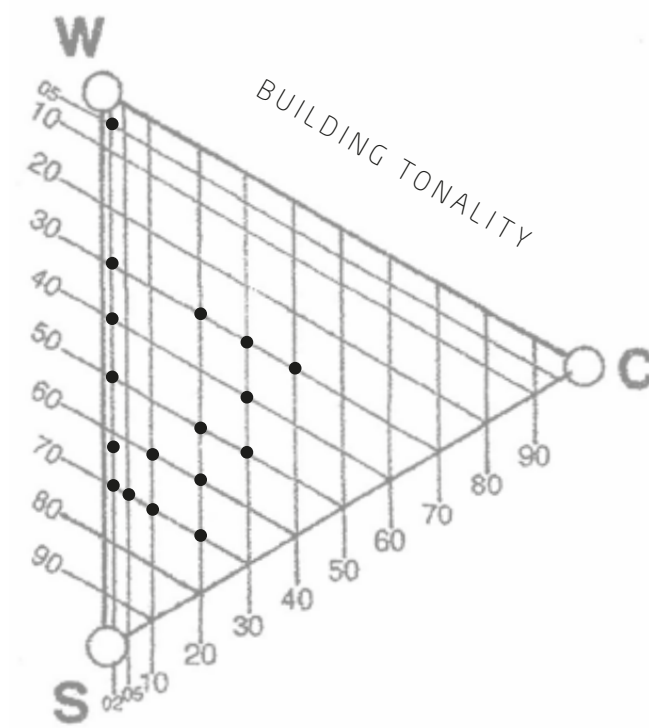
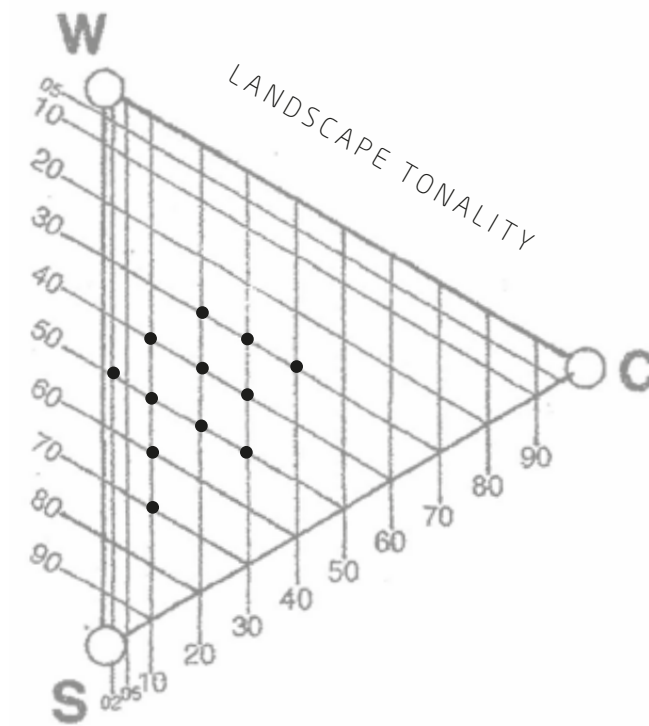

These triangular diagrams indicate the dominant tonalities recorded in this Landscape Character Area.

If you are unable to find a product which matches the colours set out in the developed palette, these diagrams indicate the acceptable range of tones which may be available in alternative colours.

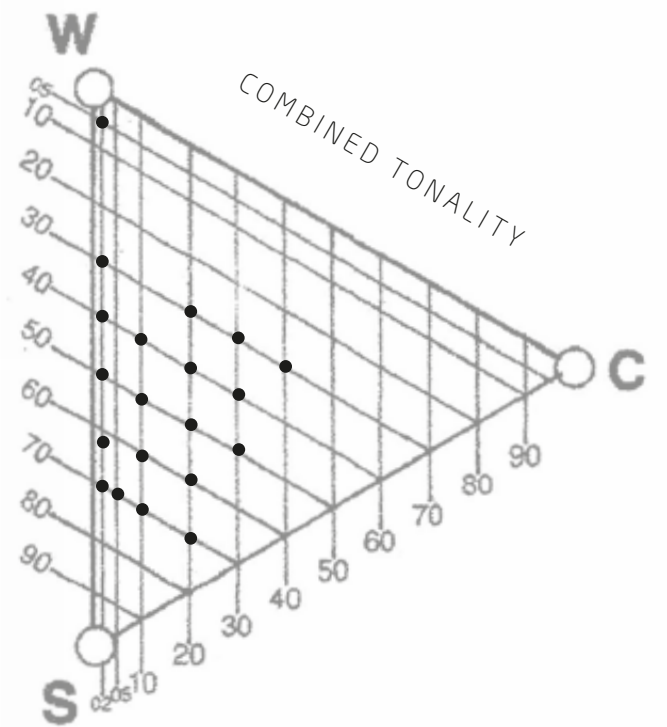



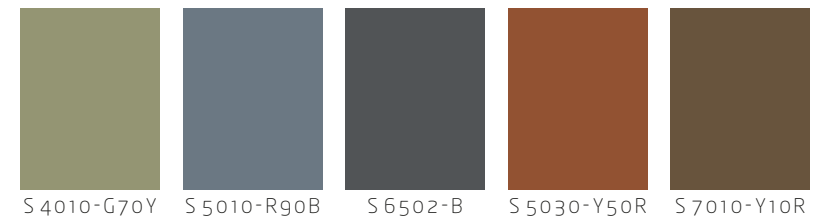
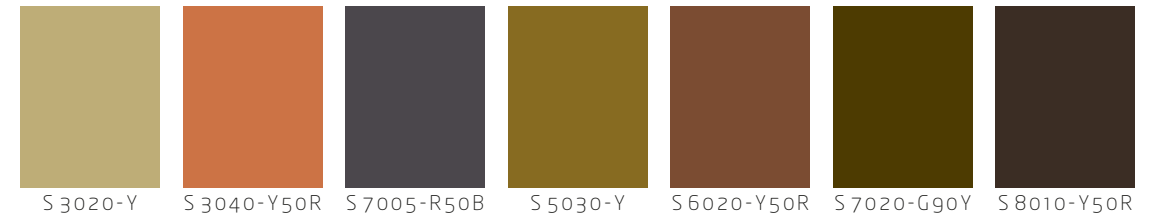
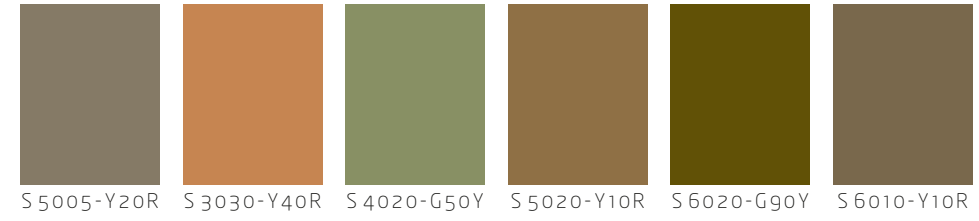
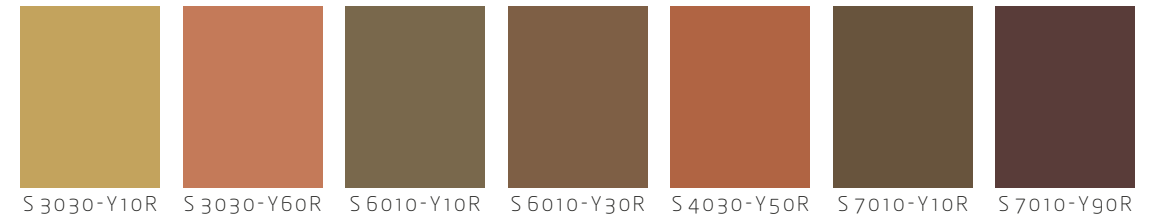



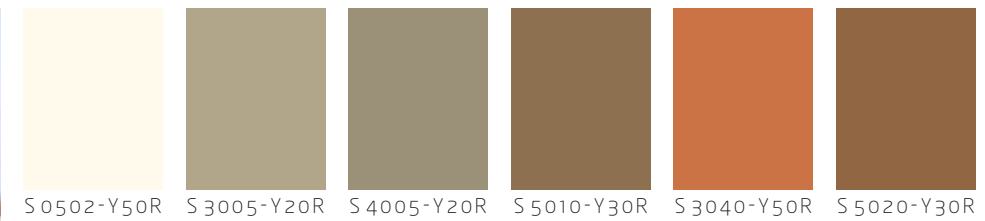
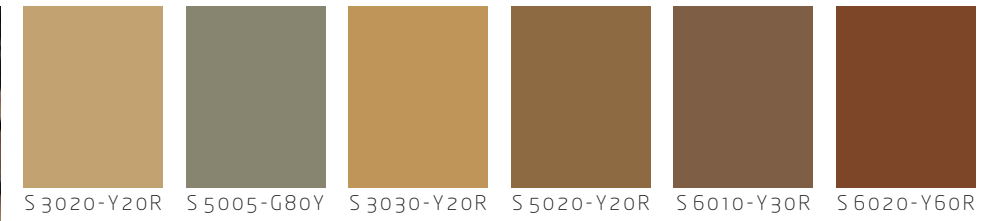
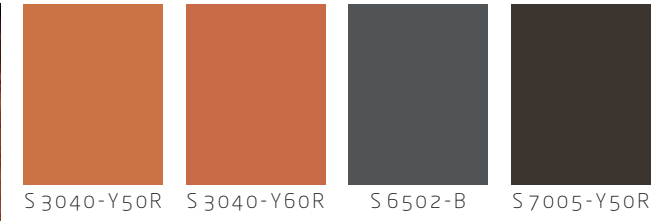
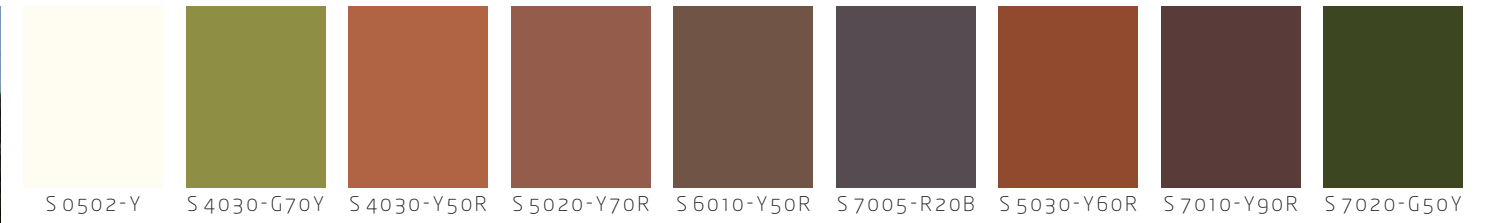



# Appendix A: Materials

Printed colours shown in this document are for guidance only.

For a true representation of colour and effect of a particular building material, please obtain samples from the relevant manufacturer or supplier. Where translations between colour specification systems are given these may not be exact but will be the nearest equivalent.

This appendix contains a list of just some of the available building materials which may be suitable for use on developments within the AONB area. This is by no means an exclusive list and the Malvern Hills AONB Partnership is not endorsing or recommending the products or manufacturers listed. Alternative materials and suppliers are available.

For conversions from NCS to RAL or BS please contact [info@ncscolour.co.uk](mailto:info@ncscolour.co.uk), or look online at [www.e-paint.co.uk](http://www.e-paint.co.uk).

## Metal Cladding and Roofing

1 **Tata Steel** ([www.colorcoat-online.com](http://www.colorcoat-online.com)) produces a range of profiled steel sheet, from which the following colours may be considered:

Colorcoat HPS200 Ultra:

Anthracite (Ral 7016) nearest NCS 7502-B.  
Merlin Grey (Ral 180 40 05) nearest NCS 6005-B20G.  
Ardenne (Ral7022) nearest NCS 7005-Y20R.  
Mole Brown (Ral 070 40 10) nearest NCS 7010-Y10R.  
Moorland Green (Ral 100 60 20) nearest NCS 4010-G70Y.  
Svelte Grey (Ral 080 50 20) nearest NCS 4005-Y20R.  
Olive Green (Ral 100 30 20) nearest NCS 7010-G50Y.  
Terracotta (Ral 040 40 40) nearest NCS 5030-Y70R.  
Juniper Green (Ral 140 20 20) nearest NCS 8010-G50Y.  
Van Dyke Brown (Ral 8014) nearest NCS 7502-Y.  
Green Grey (Ral 150 40 10) nearest NCS 6010-G10Y.  
Oxidised (Ral 050 20 10) nearest NCS 8005-Y20R.

Anthracite, Green Grey, Oxidised and Terracotta are also available as matt sheets. Matt sheets should always be

considered for roofing. Light reflection on pitched steel roofs can distort the colour substantially, rendering even dark colours as very light, a matt finish helps to reduce this risk.

Colorcoat LG is a similar range of colours as above but with a leathergrain finish and not specifically matt.

Colorcoat Prisma:

Slate Grey (Ral 7012) nearest NCS 6502-B.  
Anthracite (Ral 7016) nearest NCS 7502-B.  
Terracotta (Ral 040 40 40) nearest NCS 5030-Y70R.

Anthracite and Terracotta are also available as matt sheets and as such these should always be considered for roofing.

2 **Euroclad** ([www.euroclad.com](http://www.euroclad.com)) produce a range of metal profiled sheet. The Vieo range of wall and roof cladding uses material from the Colorcoat HPS 200 Ultra range and Colorcoat Prisma range. Standing seam cladding is also available from Tata Steel in the Colorcoat Urban range, with a similar choice of matt colours.

3 **Thomas Panels and Profiles** ([www.panelsandprofiles.co.uk](http://www.panelsandprofiles.co.uk)) produces a range of roofing and cladding sheets, sharing some of the colours with Colorcoat HPS200 Ultra:

Vandyke Brown, Merlin Grey, Olive Green, Terracotta, Juniper green.

In addition:

Svelte Grey (BS 10B 23) nearest NCS 5010-G90Y  
Slate Blue (BS18B29) nearest NCS 7502-B

4 **VMZ** ([www.vmzinc.co.uk](http://www.vmzinc.co.uk)) produces a range of cladding and roofing panels in zinc.

Natural VMZINC is shiny at first but develops a dull patina over time.

QUARTZ-ZINC is a self healing product, nearest NCS 4502-B.

ANTHRA-ZINC matches some slate colours and works well with PV panels. Nearest NCS 8505-Y20R.

PIGMENTO has the texture of QUARTZ-ZINC but is coloured:

Pigmento Blue, nearest NCS 6010-B10G,  
Pigmento Red, nearest NCS 6010-Y90R,  
Pigmento Green, nearest NCS 4005-G80Y,  
Pigmento Brown, nearest NCS 6005-Y80R.

## Fibre Cement Cladding and roofing

1 **Marley Eternit** ([www.marleyeternit.co.uk](http://www.marleyeternit.co.uk)) produce a range of fibre cement products for cladding:

Cedral Lap has a standard range of 23 colours and comes in plank sizes of 3600 mm. x 190mm. Colours worth considering include:

Sage green NCS 4010-G90Y  
Forest Grey NCS 8005-G80Y  
Pearl NCS 4005-G80Y  
Pewter NCS 5500-N  
Cream White NCS 0502-Y  
Beige NCS 0505-Y20R

Cedral Lap can be matched to any NCS co-ordinate providing the order exceeds the minimum quantity for specials.

Cedral Click tongue and groove planks are available in a standard range of 7 colours. Colours worth considering include:

Grey NCS 3502-R,  
Grey Brown NCS 3005-Y20R,  
Cream White,  
Beige.

Marley Eternit also produce through coloured fibre cement boards in the Equitone Range.

The following colours from the Natura range of Equitone are worth considering:

Natural Grey NCS 5005-G80Y  
Fossil Grey NCS 4005-G80Y  
Autumn Dusk NCS 4005-Y20R



Sepia NCS 7005-Y20R

Equitone Pictura Range, (not through coloured)

Mocha NCS 5005-Y50R

Fawn Grey NCS 3502-R

Equitone Linea Range:

Hessian NCS 4005-Y50R

Equitone Tectiva range (through coloured with grain)

Sahara NCS 3030-Y70R

Hessian NCS 4005-Y50R

Linen NCS 2005-Y20R

Calico NCS 1002-Y50R.

Marley Eternit also produce profiled fibre cement for roofing. Within their range the following colours may be useful:

Tawny Brown NCS 3040-Y60R

Bracken NCS 5010-Y50R

Van Dyke Brown NCS 7502-Y

Anthracite NCS 6502-Y

Blue NCS 7502-B

Laurel NCS 8010-G50Y

## Render

1 **K Rend** ([www.k-rend.co.uk](http://www.k-rend.co.uk)) produce silicone thin coat render in a wide range of NCS colours. An NCS fan deck is available from their Technical Support Centre.

2 **Wetherby Building Systems** ([www.wbs-ltd.co.uk](http://www.wbs-ltd.co.uk)) produce thin coat renders to cover external insulation refurbishments. The HECK range offers a wide range of NCS colours, including:

1010-Y20R

1010Y

1015Y

0520-G90Y

0520-Y10R

0520-Y20R

3030-Y50R

5010-B90G

2030-Y10R

4005-R50B

5502-Y

5502-B

7500-N

3 **Tŷ Mawr** ([www.lime.org.uk](http://www.lime.org.uk)) offers a range of premixed natural hydraulic limes, such as St. Astier EcoMortar C, F and WP to a standard range but will also mix to any NCS colour.

Tŷ Mawr also provides Glaster, a mix of lime binder with recycled glass aggregate suitable for external and internal applications with colour provided by the glass and natural pigments added to the lime.

## Masonry Paint

1 **Dulux Trade** ([www.duluxtrade.co.uk](http://www.duluxtrade.co.uk)) offer Weathershield for exterior wood, metal and masonry. The colour palette bears similarities with NCS and Dulux tinting machines recognize NCS coordinates. Dulux also produce a range of Heritage finishes derived from research into period colours.

2 **Armstead Trade** ([www.armsteadtrade.co.uk](http://www.armsteadtrade.co.uk)) part of the Akzo Nobel group as are Dulux offer a fan deck with the full range of 1950 NCS colours.

3 **Crown Trade** ([www.crowntrade.co.uk](http://www.crowntrade.co.uk)) offer Sandtex for exterior wood, metal and masonry with a similar colour range to Dulux and with tint machines which also recognize NCS codes. Crown also produce a range of historic colours.

4 **Keim Mineral Paints** ([www.keimpaints.co.uk](http://www.keimpaints.co.uk)) have a wide range of breathable mineral and silicate paints to suit a variety of substrates and conditions. Equivalent NCS references can be given for their range upon request.

5 **Tŷ Mawr** ([www.lime.org.uk](http://www.lime.org.uk)) have a wide range of mineral based paint for interior and exterior situations. All Tŷ Mawr paint products are classified using NCS coordinates.

## Wood finishes

1 **Dulux Trade** ([www.duluxtrade.co.uk](http://www.duluxtrade.co.uk)) offer a range of 600 colours in their opaque wood stain collection. They also offer a designer range and a natural wood colour range though only some of these are suitable for exterior application. As with the trade palette NCS coordinates can be recognized by tinting machines.

2 **Sikkens** ([www.sikkens.co.uk](http://www.sikkens.co.uk)) are also part of the AkzoNobel group and offer a variety of professional woodcare systems. Rubbol exterior opaque coating system offers colours from NCS, Ral, BS4800 and their own 4041 colour concept range. The Cetol Systems for Exterior offers two collections, Classic and Style with finishes in translucent and opaque, matches to NCS will need to be made by visual comparison.

3 **Beeck** ([www.beeck.com](http://www.beeck.com)) produce plant-based wood paint in semi-gloss finish to NCS classification. It is available in the UK through Tŷ Mawr.

4 **Crown** ([www.sadolin.co.uk](http://www.sadolin.co.uk)) produce Sadolin wood stains in opaque and translucent finishes using their own colour range for Superdec and Beach Hut colours, they also offer colours in Ral Classic and BS4800.

Translation tables exist between Ral and NCS.

## Building Boards

1 **Rock Panel** ([www.rockpanel.co.uk](http://www.rockpanel.co.uk)) produce compressed pre formed building boards for cladding in a range of 24 standard colours. For orders in excess of 100m any NCS colour may be specified. NCS equivalents for the standard range may be given upon request.

2 **Trespa** ([www.trespa.com](http://www.trespa.com)) produce building boards in a standard range of 67 colours. Special colours can be produced for significant projects.



Colours worth considering include:

Mid Grey NCS 5000-N  
Taupe NCS 6010-Y90R  
Cactus Green NCS 4010-G70Y  
Natural Greige NCS 6005-Y50R

## Bricks

There are very many bricks available on the market, this selection has been made to get reasonable matches to the range of traditional bricks found within the AONB area.

### 1 **Furness Brick** ([www.furnessbrick.co.uk](http://www.furnessbrick.co.uk))

Natural orange NCS 3040-Y50R  
Grey brown NCS 6010-Y50R  
Burlington Orange NCS

### 2 **Terca** ([www.weinerberger.co.uk](http://www.weinerberger.co.uk))

Autumn Russet Sovereign Stock NCS 3030-Y60R  
Witton Multi Stock NCS 3050-Y50R  
Warnham terracotta stock NCS 3050-Y50R

### 3 **Ibstock** ([www.ibstock.com](http://www.ibstock.com))

Mercia Orange NCS 5030-Y50R  
Himley Worcestershire Mix NCS 5030-Y50R  
Berkshire Orange Stock NCS 4040-Y50R

It should be noted that due to variation in brick colours, especially multis, the colour reference is approximate only and other factors such as texture and finish should be considered when choosing bricks. A sample panel of a metre square is advisable when selecting bricks.

## Mortar

The colour of pointing mortar can have a profound effect on the appearance of brickwork, and to a lesser extent on blockwork. The sample panel of brickwork referred to above is also the opportunity to test mortar colours.

1 **Tarmac** ([www.tarmac.com/mortar/mortar](http://www.tarmac.com/mortar/mortar)) produce over 50 shades of factory produced mortar.

For the brick colours mentioned above, use a mid tone to dark grey from 5005-7005 on the NCS grey tint scale

Tarmac Y79 is a dark lilac NCS 7005-R20B and works well with bricks NCS 3040-Y50R. Y80 and Y76 are also worth considering.

2 **Premier Mortars** ([www.premiermortars.co.uk](http://www.premiermortars.co.uk)) have a similar range of 48 shades of mortar, PM66, PM92, and PM94 are worth sampling alongside your brick panels.

3 **Tŷ Mawr** ([www.lime.org.uk](http://www.lime.org.uk)) supply natural hydraulic lime mortars for natural breathability and elasticity:

Lithomex Stone Resoration and Repair Mortar comes in 4 standard colours and can also be colour matched to a particular stone.  
Hourdex is a grey mortar.  
RJ35 Pre-mixed lime mortar is available in many shades of beige.

## Clay tiles and slates

Clay tiles come in many profiles, the plain tile with a cross cambered surface is traditional to the area.

1 **Sandtoft** ([www.sandtoft.com](http://www.sandtoft.com)) produce natural clay plain tiles:

Village Plain Reclaimed NCS 7020-Y80R, NCS 8010-Y90R, NCS 6020-Y80R.  
Alban Plain Tile, Sussex Blend NCS as above but greater proportion of darker tones.  
Handcrafted plain Tile in Lichen Green is also worth consideration.

Concrete tiles are generally not acceptable in the area.

Slates are also common place in the area, traditionally from Wales. Welsh slate can still be purchased, though generally at a premium price.

2 **Welsh Slate Ltd** ([www.welshslate.com](http://www.welshslate.com)) produce roofing colours as follows:

Cwt-y-bugail a dark blue grey slate  
Penrhyn a heather blue slate

Cheaper real slate is imported from Spain. The colour varies with the quarry from which it comes.

3 **Stoneleaf** ([www.stoneleafslates.co.uk](http://www.stoneleafslates.co.uk)) supplies a slate close to the hue of welsh slate, called Celtic Grey.

Reclaimed Welsh slate can be found from architectural reclamation yards.

4 **Monier Redland** ([www.monier.co.uk](http://www.monier.co.uk)) produce manufactured slate which once weathered is a viable substitute to real slate:

Cambian Heather  
Cambrian grey weathered

## Aggregates for landscaping

It is important that the strong local colour range is reflected in the use of sands, gravels and aggregates within developments.

1 **Radbournes** ([www.radbournes.co.uk](http://www.radbournes.co.uk)) supply a range of decorative aggregates some of which come from relatively local sources:

Hereford gravel comes in 6mm-20mm sizes and ranges from pink to grey, the smaller aggregate has an overall colour of NCS 6010-Y70R to NCS 5020-Y60R.

Malvern stone sits at Y50R to Y80R with a nuance of 5030 to 6020 so this is a reasonable match.

Other aggregates from Radbournes include:

Weeford 14mm from Shropshire

Forest of Dean clean 10mm-20mm from Gloucestershire. Though not directly from this area the colour sits within a range of local stone.



The following bodies provide financial support to the Malvern Hills AONB Partnership



Malvern Hills AONB Partnership  
Manor House, Grange Road  
Malvern, Worcestershire WR14 3EY

Tel: 01684 560616  
Fax: 01684 577457

Email: [aonb@worcestershire.gov.uk](mailto:aonb@worcestershire.gov.uk)  
Web: [www.malvernhillsaonb.org.uk](http://www.malvernhillsaonb.org.uk)